



*SINGLE SOURCE...  
ELECTRICAL & LIGHTING*

# **LIGHTING**

*2024 / 2025*

# WHAT'S NEW

**AREA  
LIGHTS**



**MINI /  
SLIM-LINE  
WALLPACKS**



**BOLLARDS**



**SPORTS LIGHTS /  
HIGH POWER FLOODS**

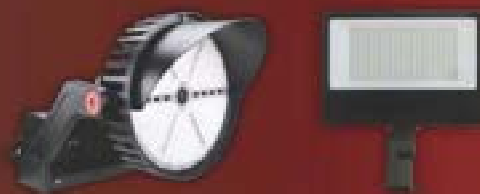

**GOOSENECKS**



**UFO HIGH BAYS**



**SECURITY LIGHTS**





**AREA LIGHTS**

*1-2*



**WALLPACKS /  
CANOPIES**

*4-7*



**BOLLARDS**

*8*



**SPORTS LIGHTS /  
HIGH POWER FLOODS**

*9-11*



**FLOODS /  
SECURITY**

*11-15*



**PHOTOCELLS**

*16-17*



**HIGH BAYS**

*18-20*



**PANELS /  
TROFFERS**

*21*

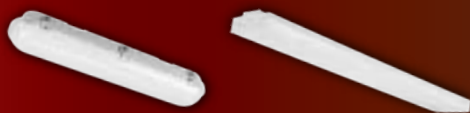

**VAPORTIGHT /  
WRAPS**

*22-26*



**DOWNLIGHTING /  
RETROFITS**

*27-31*

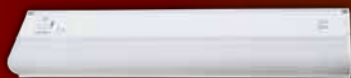

**UNDERCABINET**

*32*

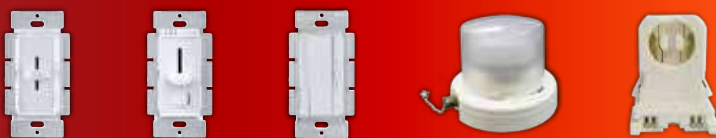

**DIMMERS / SENSORS  
/ TIME CONTROLS**

*33-36*



**EXIT &  
EMERGENCY**

*37-43*



**COLOR & WATTAGE SELECTABLE**  
**AREA LIGHT GEN 5**  
**WITH FIELD CHANGABLE LENS**



**TYPE III INSTALLED, TYPE IV & V AVAILABLE SEPARATELY - FREE OF CHARGE!**  
**TOOL-LESS DRIVER BOX ACCESS**  
**HIGHER LUMENS PER WATT THAN PREVIOUS MODELS**  
**LOCK THE LENS WITH A SCREWDRIVER**



- Twist Lock Receptacle & Shorting Cap Included
- Polycarbonate Lens
- IP65 Rated
- 3000K, 4000K or 5000K
- Dimming: 0-10V
- Corrosion Resistant Die-Cast Aluminum Housing

Area Lights

CAT. NO.	WATTS	VOLTS	HOUSING COLOR	LUMENS	LM/W	WEIGHT (LBS)	CASE QTY
<b>TYPE III LENS INSTALLED IV &amp; V AVAILABLE SEPARATELY (FIXTURE ONLY - ORDER MOUNTS SEPARATELY)</b>							
74010D	80W 100W 150W	120-277V	BRONZE	20,495	137	12.35	1
74012D	80W 100W 150W	120-277V	WHITE	20,495	137	12.35	1
74026D	200W 240W 300W	120-277V	BRONZE	40,555	136	13.89	1
74029D	200W 240W 300W	120-277V	WHITE	40,555	136	13.89	1
74014D	80W 100W 150W	277-480V	BRONZE	21,200	136	12.35	1
74030D	200W 240W 300W	277-480V	BRONZE	40,823	136	13.89	1
<b>ACCESSORIES</b>							
74072C	MICROWAVE MOTION SENSOR						100
74188B	REMOTE CONTROL FOR MICROWAVE MOTION SENSOR						100
39106	LED TWIST LOCK PHOTOCELL 120-277V						100
39107	LED TWIST LOCK PHOTOCELL 277-480V						100
74786D	TYPE IV LENS FOR 80/100/150W FIXTURES						50
74788D	TYPE IV LENS FOR GEN 5 200/240/300W FIXTURES						50
74787D	TYPE V LENS FOR GEN 5 80/100/150W FIXTURES						50
74206D	TYPE V LENS FOR GEN 5 200/240/300W FIXTURES						50
75093D	GLARE SHIELD FOR 80/100/150W BRONZE AREA LIGHTS						10
75089D	GLARE SHIELD FOR 200/240/300W BRONZE AREA LIGHTS						10
74036D	YOKE MOUNT FOR 80/100/150W BRONZE FIXTURES						10
74037D	YOKE MOUNT FOR 80/100/150W WHITE FIXTURES						10
74737D	YOKE MOUNT FOR 200/240/300W BRONZE FIXTURES						10
74738D	YOKE MOUNT FOR 200/240/300W WHITE FIXTURES						10
74032A	POLE ARM MOUNT FOR 80W-300W BRONZE FIXTURES						10
74033A	POLE ARM MOUNT FOR 80W-300W WHITE FIXTURES						10
74034A	SLIPFITTER MOUNT FOR 80W-300W BRONZE FIXTURES						10
74035A	SLIPFITTER MOUNT FOR 80W-300W AREA WHITE LIGHTS						10
74038C	TRUNNION MOUNT FOR 80W-300W BRONZE AREA LIGHTS						10
74039C	TRUNNION MOUNT FOR 80W-300W WHITE AREA LIGHTS						10
74043A	UNIVERSAL MOUNT FOR 80W-300W BRONZE AREA LIGHTS						10
74044A	UNIVERSAL MOUNT FOR 80W-300W WHITE AREA LIGHTS						10

PLEASE REVIEW ONLINE SPECIFICATION SHEETS. IMAGES AND CERTIFICATIONS MAY NOT BE 100% REPRESENTATIVE OF ALL PRODUCTS LISTED. TO VIEW DETAILS OF OUR DLC QUALIFIED PRODUCTS, PLEASE CONSULT THE DLC QUALIFIED PRODUCTS LIST AT [WWW.DESIGNLIGHTS.ORG/QPL](http://WWW.DESIGNLIGHTS.ORG/QPL)

# AREA LIGHT

**WITH UNIVERSAL MOUNT**

SLIPFITTER WALL/SURFACE MOUNT POLE MOUNT

# ALL-IN-ONE



**74700D**

**EVERYTHING YOU NEED IN ONE BOX!**

**COLOR & WATTAGE SELECTABLE**

**80/100/150W Area Light**

**3000K/4000K/5000K**

**Universal Mount**

**Type III/IV/V Lenses  
(Type III Installed)**

**Photocell & Shorting Cap**



**FIELD CHANGEABLE LENS -  
TYPE III INSTALLED ON FIXTURE**



CAT. NO.	LIGHT PATTERN	WATTS	VOLTS	COLOR TEMP	HOUSING COLOR	LUMENS @ MAX WATTS	LM/W	WEIGHT (LBS)	CASE QTY
<b>TYPE III LENS INSTALLED TYPE IV &amp; V INCLUDED</b>									
74700D	III	80W 100W 150W	120-277V	3000K 4000K 5000K	BRONZE	22,521	137	16.1	1



# POLE TOP TENON MOUNTING ACCESSORIES ALL MOUNTING ACCESSORIES ARE POWDER COATED BRONZE FINISH



CAT. NO.	FIG.	TYPE	POLE SIZE	APPLICATION	WEIGHT CAPACITY (LBS)	EPA RATING	WEIGHT (LBS)	CASE QTY
79912	1	SQUARE SHORT TENON	4"	SQUARE POLE	100	0.15	5.5	6
79913	1	SQUARE SHORT TENON	5"	SQUARE POLE	100	0.15	5.6	6
79914	2	SQUARE LONG TENON	3"	SQUARE POLE	100	0.16	5.7	4
79915	2	SQUARE LONG TENON	4"	SQUARE POLE	100	0.16	5.7	4
79916	2	SQUARE LONG TENON	5"	SQUARE POLE	100	0.16	6.5	4
79917	3	ROUND LONG TENON	3"	ROUND POLE	100	0.26	5	4
79918	3	ROUND LONG TENON	4"	ROUND POLE	100	0.26	6.3	4
79919	3	ROUND LONG TENON	5"	ROUND POLE	100	0.30	7.6	4
79922	4	90° SQUARE BRACKET	4"	POLE TOP - 1 TENON	60	0.20	5.9	4
79923	4	90° SQUARE BRACKET	5"	POLE TOP - 1 TENON	60	0.27	6.6	4
79926	5	90° SQUARE BRACKET	4"	POLE TOP - 2 TENON OPPOSITE	60	0.26	6.6	4
79927	5	90° SQUARE BRACKET	5"	POLE TOP - 2 TENON OPPOSITE	60	0.34	7.5	4
79930	6	90° SQUARE BRACKET	4"	POLE TOP - 2 TENON 90°	60	0.20	6.4	4
79931	6	90° SQUARE BRACKET	5"	POLE TOP - 2 TENON 90°	60	0.27	7.5	4
79934	7	90° SQUARE BRACKET	4"	POLE TOP - 3 TENON 90°	60	0.26	7.6	4
79935	7	90° SQUARE BRACKET	5"	POLE TOP - 3 TENON 90°	60	0.34	8.4	4
79938	8	90° SQUARE BRACKET	4"	POLE TOP - 4 TENON 90°	60	0.26	8.4	4
79939	8	90° SQUARE BRACKET	5"	POLE TOP - 4 TENON 90°	60	0.34	9.3	4
79951	9	ROUND SINGLE STRAIGHT ARM	2-3/8" SLIPFITTER	ROUND POLE TOP - 1 TENON	35	0.4	4.4	1
79953	10	180° ROUND VERTICAL TENNON	2-3/8" SLIPFITTER	ROUND POLE TOP - 2 TENON - OPPOSITE	70	0.4	6	1
79955	11	90° ROUND DOUBLE STRAIGHT ARM	2-3/8" SLIPFITTER	ROUND POLE TOP - 2 TENON - 90°	70	0.6	7	1
79957	12	120° ROUND TRIPLE STRAIGHT ARM	2-3/8" SLIPFITTER	ROUND POLE TOP - 3 TENON - 120°	105	0.7	9	1
79959	13	90° ROUND QUAD STRAIGHT ARM	2-3/8" SLIPFITTER	ROUND POLE TOP - 4 TENON - 90°	141	1.3	11	1

## ROUND POLE BULLHORNS



CAT. NO.	FIG.	TYPE	SIZE	APPLICATION	FINISH	WEIGHT CAPACITY (LBS)	EPA RATING	WEIGHT (LBS)
79960	1	ROUND 2 TENON HORIZONTAL BULLHORN	2-3/8" TENON	POLE/TENON MOUNT	BRONZE POWDER COAT	70	1.0	29
79952	2	ROUND 2 TENON VERTICAL BULLHORN	2-3/8" TENON	POLE/TENON MOUNT	BRONZE POWDER COAT	100	1.0	29
79954	3	ROUND 3 TENON VERTICAL BULLHORN	2-3/8" TENON	POLE/TENON MOUNT	BRONZE POWDER COAT	100	1.6	34

## SQUARE POLE BULLHORNS



CAT. NO.	FIG.	TYPE	SIZE	APPLICATION	FINISH	WEIGHT CAPACITY (LBS)	EPA RATING	WEIGHT (LBS)
79944A	1	4" SQUARE 2 TENON 180° BULLHORN	4" POLE TO 2-3/8" TENON	POLE MOUNT	BRONZE POWDER COAT	60	1	29
79946A	2	4" SQUARE 3 TENON 180° BULLHORN	4" POLE TO 2-3/8" TENON	POLE MOUNT	BRONZE POWDER COAT	60	1.7	30
79945A	3	4" SQUARE 4 TENON 180° BULLHORN	4" POLE TO 2-3/8" TENON	POLE MOUNT	BRONZE POWDER COAT	60	2.4	30
79950A	4	4" SQUARE 4 ARM 90° BULLHORN	4" POLE TO 2-3/8" TENON	POLE MOUNT	BRONZE POWDER COAT	60	1.3	13
79947A	5	3" POLE TO 4" BULLHORN ADAPTOR	3" TO 4"	POLE MOUNT	BRONZE POWDER COAT	100	N/A	2
79949A	5	5" POLE TO 4" BULLHORN ADAPTOR	5" TO 4"	POLE MOUNT	BRONZE POWDER COAT	100	N/A	2

## MOUNTING ACCESSORIES

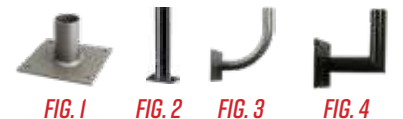

CAT. NO.	FIG.	TYPE	SIZE	APPLICATION	FINISH	WEIGHT CAPACITY (LBS)	EPA RATING	WEIGHT (LBS)	CASE QTY
79903	1	SHORT STRAIGHT BRACKET	4"	WALL MOUNT	BRONZE POWDER COAT	60	0.07	3.7	4
79904	2	LONG STRAIGHT BRACKET	8"	WALL MOUNT	BRONZE POWDER COAT	60	0.18	4.7	4
79907	3	90° SWEEP BRACKET	8"	90° WALL MOUNT	BRONZE POWDER COAT	60	0.34	8.2	4
79908	4	90° BRACKET	8"	90° WALL MOUNT	BRONZE POWDER COAT	60	0.22	6.3	4

Mounting / Bullhorns



# CLASSIC WALLPACKS WITH PHOTOCELL



- 0-10V Dimming
- Integrated Photocell with On/Off Switch
- Die-Cast Aluminum Housing
- Heat Resistant Optics



CAT. NO.	WATTS	COLOR TEMP	VOLTS	HOUSING COLOR	LUMENS	CASE QTY
<b>SMALL WALLPACKS 9" WIDTH</b>						
71435D	30W	5000K	120-277V	BRONZE	4,184	1
71436D	30W	5000K	120-277V	WHITE	4,184	1
71630D	30W	4000K	120-277V	BRONZE	3,714	1
71637D	45W	5000K	120-277V	BRONZE	5,780	1
71638D	60W	5000K	120-277V	BRONZE	7,436	1
<b>MEDIUM WALLPACKS 14" WIDTH</b>						
71437D	45W	5000K	120-277V	BRONZE	5,685	1
71631D	45W	4000K	120-277V	BRONZE	5,539	1
71425D	60W	5000K	120-277V	BRONZE	7,919	1
71428D	60W	5000K	120-277V	WHITE	7,919	1
71426D	75W	5000K	120-277V	BRONZE	9,394	1
71429D	75W	5000K	120-277V	WHITE	9,394	1
71431D	90W	5000K	120-277V	BRONZE	11,345	1
71634D	90W	4000K	120-277V	BRONZE	10,765	1
71472D	120W	5000K	120-277V	BRONZE	14,764	1
71424D	60W	5000K	277-480V	BRONZE	8,042	1
71449D	75W	5000K	277-480V	BRONZE	9,514	1
<b>ACCESSORIES (MEDIUM WALLPACKS ONLY)</b>						
71465C	EMERGENCY BACKUP FOR 45W-60W 120-277V MEDIUM WALLPACKS					1
71470C	EMERGENCY BACKUP FOR 75W-120W 120-277V MEDIUM WALLPACKS					1
71461B	SEMI-CUTOFF VISOR BRONZE					8
71430B	SEMI-CUTOFF VISOR WHITE					8
71427C	FULL CUTOFF VISOR BRONZE					10
71459B	WIRE GUARD					10
<b>LARGE WALLPACKS 18" WIDTH</b>						
71440D	120W	5000K	120-277V	BRONZE	15,721	1
71441D	120W	5000K	120-277V	WHITE	15,721	1
<b>ACCESSORIES (LARGE WALLPACKS ONLY)</b>						
71470C	EMERGENCY BACKUP FOR 120W 120-277V LARGE WALLPACKS					1
71463B	SEMI-CUTOFF VISOR BRONZE					8
71443B	SEMI-CUTOFF VISOR WHITE					8
71442C	FULL CUTOFF VISOR BRONZE					10

## COLOR & WATTAGE SELECTABLE WALLPACKS WITH PHOTOCELL

- Voltage: 120-277V
- 0-10V Dimming
- Integrated Photocell with On/Off Switch
- Die-Cast Aluminum Housing
- Heat Resistant Optics



CAT. NO.	WATTS	COLOR TEMP	HOUSING COLOR	LUMENS @ MAX WATTS	CASE QTY	
<b>MEDIUM WALLPACKS - COLOR &amp; WATTAGE SELECTABLE 14" WIDTH</b>						
71475D	36W	3000K	BRONZE	8,455	1	
	45W	4000K				
	60W	5000K				
71476D	60W	3000K	BRONZE	10,973	1	
	75W	4000K				
	90W	5000K				
71477D	60W	3000K	WHITE	10,973	1	
	75W	4000K				
	90W	5000K				
<b>ACCESSORIES</b>						
71461B	SEMI-CUTOFF VISOR BRONZE					8
71430B	SEMI-CUTOFF VISOR WHITE					8
71427C	FULL CUTOFF VISOR BRONZE					10
71459B	WIRE GUARD					10



# CLASSIC FULL CUTOFF WALLPACKS



- Voltage: 120-277V
- 0-10V Dimming
- Die-Cast Aluminum Housing
- High Quality Tempered Glass Lens

CAT. NO.	WATTS	HOUSING COLOR	LUMENS	DIMENSIONS			CASE QTY
				W	H	D	
71452C	45W	BRONZE	5,580	13"	9.25"	11.25"	1
71451C	60W	BRONZE	7,038	13"	9.25"	11.25"	1
71454C	75W	BRONZE	8,840	13"	9.25"	11.25"	1
71457C	90W	BRONZE	11,103	13"	9.25"	11.25"	1

# COLOR & WATTAGE SELECTABLE SLIM-LINE FLOOD / WALLPACK



- Voltage: 120-277V
- Die-Cast Aluminum Housing
- Hinged Bracket - 0-90° Angle Tilt Adjustment

CAT. NO.	WATTS	COLOR TEMP	HOUSING COLOR	LUMENS @ MAX WATTS	DIMENSIONS			CASE QTY
					LENGTH	HEIGHT	DEPTH (WI)	
71152C	15W	3000K	BRONZE	3,810	7.15"	7.40"	4.58"	4
	20W	4000K						
	30W	5000K						
71154C	30W	3000K	BRONZE	6,880	8.39"	9.06"	5.00"	2
	40W	4000K						
	50W	5000K						
71156C	60W	3000K	BRONZE	11,140	8.39"	9.06"	5.00"	2
	70W	4000K						
	80W	5000K						
71158C	80W	3000K	BRONZE	16,740	9.96"	11.42"	6.42"	1
	100W	4000K						
	120W	5000K						

PLEASE REVIEW ONLINE SPECIFICATION SHEETS. IMAGES AND CERTIFICATIONS MAY NOT BE 100% REPRESENTATIVE OF ALL PRODUCTS LISTED. TO VIEW DETAILS OF OUR DLC QUALIFIED PRODUCTS, PLEASE CONSULT THE DLC QUALIFIED PRODUCTS LIST AT [WWW.DESIGNLIGHTS.ORG/QPL](http://WWW.DESIGNLIGHTS.ORG/QPL)





# COLOR & WATTAGE SELECTABLE MINI WALLPACKS **NEW**



- Color Selectable: 3000K, 4000K or 5000K
- Wattage Selectable: 13W, 20W or 26W
- Voltage: 120-277V
- Integrated Photocell with On/Off Switch
- Die-Cast Aluminum Housing
- Frosted Polycarbonate Lens

HIGHER LUMENS PER WATT  
THAN PREVIOUS MODELS  
MODERN DESIGN



Mini Wallpacks

CAT. NO.	PHOTOCELL	HOUSING COLOR	LUMENS @ MAX WATTS	CASE QTY
71423C	YES	BRONZE	4,150	4
71419C	YES	WHITE	4,150	4



# COLOR & WATTAGE SELECTABLE DESIGNER MINI WALLPACK

- Color Selectable: 3000K, 4000K or 5000K
- Wattage Selectable: 13W, 18W or 26W
- Voltage: 120-277V
- Integrated Photocell with On/Off Switch
- Die-Cast Aluminum Housing
- Frosted Polycarbonate Lens

HIGHER LUMENS PER WATT  
THAN PREVIOUS MODELS  
ON/OFF SWITCH FOR PHOTOCELL



CAT. NO.	PHOTOCELL	HOUSING COLOR	LUMENS @ MAX WATTS	CASE QTY
71527C	YES	BRONZE	3,546	10
71519C	YES	WHITE	3,546	10

PLEASE REVIEW ONLINE SPECIFICATION SHEETS. IMAGES AND CERTIFICATIONS MAY NOT BE 100% REPRESENTATIVE OF ALL PRODUCTS LISTED. TO VIEW DETAILS OF OUR DLC QUALIFIED PRODUCTS, PLEASE CONSULT THE DLC QUALIFIED PRODUCTS LIST AT [WWW.DESIGNLIGHTS.ORG/QPL](http://WWW.DESIGNLIGHTS.ORG/QPL)



## COLOR & WATTAGE SELECTABLE

# CANOPY



- 0-10V Dimmable
- Voltage: 120-277V
- Integrated Photocell with On/Off Switch
- IP65 Wet Location Rated
- 50,000+ Hour Life Expectancy

CAT. NO.	WATTS	HOUSING COLOR	COLOR TEMP	LUMENS	REPLACES METAL HALIDE	CASE QTY
71603C	30W 40W 50W	BRONZE	3000K 4000K 5000K	6,500	100W-150W	5
71604C	30W 40W 50W	WHITE	3000K 4000K 5000K	6,500	100W-150W	5
71609C	45W 60W 75W	BRONZE	3000K 4000K 5000K	9,750	150W-250W	5
71610C	45W 60W 75W	WHITE	3000K 4000K 5000K	9,750	150W-250W	5

## ULTRATHIN RECESSED CANOPY

SURFACE OR RECESS MOUNT GARAGE CANOPY



FIXTURE SHOWN WITH RECESSED MOUNT TRIM  
SOLD SEPARATELY CAT. NO. 71620

CAT. NO.	WATTS	VOLTS	HOUSING COLOR	COLOR TEMP	LUMENS	BEAM ANGLE	CASE QTY
71622	40W	120-277V	WHITE	5000K	4,402	148°	1
71624	60W	120-277V	WHITE	5000K	6,100	153°	1
<b>RECESSED MOUNT TRIM PLATE</b>							
71620	GARAGE CANOPY - RECESSED MOUNT TRIM						3

## GAS STATION/RECESSED CANOPY



CAT. NO.	WATTS	VOLTS	MOUNTING	LUMENS	DIMENSIONS			CASE QTY
					HI	H2	W	
71413A	150W	120-277V	RECESSED	21,043	9.625"	5"	20.50"	1

## GAS STATION SURFACE MOUNT CANOPY



CAT. NO.	WATTS	VOLTS	MOUNTING	LUMENS	CASE QTY
71411A	120W	120-277V	SURFACE	15,802	1
71412A	150W	120-277V	SURFACE	19,379	1
<b>ACCESSORIES</b>					
71414A	SURFACE MOUNT BRACKET				1

PLEASE REVIEW ONLINE SPECIFICATION SHEETS. IMAGES AND CERTIFICATIONS MAY NOT BE 100% REPRESENTATIVE OF ALL PRODUCTS LISTED. TO VIEW DETAILS OF OUR DLC QUALIFIED PRODUCTS, PLEASE CONSULT THE DLC QUALIFIED PRODUCTS LIST AT WWW.DESIGNLIGHTS.ORG/QPL

# COLOR & WATTAGE SELECTABLE LED BOLLARDS

**NEW**

- Voltage: 120-277V
- Anchor Bolts Included with Base
- Corrosion Resistant Die-Cast Aluminum Housing

- GREATER WATERPROOF PROTECTION FOR DRIVER & DIP SWITCHES
- ADDITIONAL DIP SWITCH FOR ON/OFF PHOTOCELL
- INCREASED SURGE PROTECTION - FROM 4KV TO 6KV
- HIGHER WATTAGE RANGE
- SAME BOLT PATTERN FOR EASY REPLACEMENT OF EXISTING FIXTURE

**FOR ROUND BOLLARDS COMBINE ROUND BASE & ONE OF 2 ROUND TOPS FOR COMPLETE FIXTURE**



FIG. 1



FIG. 2



FIG. 3

## ANCHOR BOLTS & MOUNTING TEMPLATE INCLUDED WITH BASE

CAT. NO.	FIG.	DESCRIPTION	COLOR TEMP	WATTS	LUMENS @ MAX WATTS	HOUSING COLOR	CASE QTY
<b>SQUARE BOLLARDS</b>							
72302A	1	SQUARE - BASE AND TOP	3000K 4000K 5000K	14W 19W 24W	3,360	BRONZE	1
72322A	1	SQUARE - BASE AND TOP	3000K 4000K 5000K	14W 19W 24W	3,360	BLACK	1
<b>ROUND BOLLARDS - BRONZE</b>							
72310A	-	ROUND - BASE ONLY	-	-	-	BRONZE	1
72312A	2	ROUND LOUVERED DOME - TOP ONLY	3000K 4000K 5000K	14W 19W 24W	1,800	BRONZE	4
72313A	3	ROUND FLAT - TOP ONLY	3000K 4000K 5000K	14W 19W 24W	3,360	BRONZE	4
<b>ROUND BOLLARDS - BLACK</b>							
72330A	-	ROUND - BASE ONLY	-	-	-	BLACK	1
72332A	2	ROUND LOUVERED DOME - TOP ONLY	3000K 4000K 5000K	14W 19W 24W	1,800	BLACK	4
72333A	3	ROUND FLAT - TOP ONLY	3000K 4000K 5000K	14W 19W 24W	3,360	BLACK	4

PLEASE REVIEW ONLINE SPECIFICATION SHEETS. IMAGES AND CERTIFICATIONS MAY NOT BE 100% REPRESENTATIVE OF ALL PRODUCTS LISTED. TO VIEW DETAILS OF OUR DLC QUALIFIED PRODUCTS, PLEASE CONSULT THE DLC QUALIFIED PRODUCTS LIST AT [WWW.DESIGNLIGHTS.ORG/QPL](http://WWW.DESIGNLIGHTS.ORG/QPL)



**NEW**

# HOTSHOT™ SPORTS LIGHTER



- Beam Adjustable up to 240° Tilt / 220° Rotation
- 0-10V Dimmable
- 10KV Surge Supression Standard



**REMOTE DRIVER BOX - LOWERS OVERALL FIXTURE TEMPERATURE & ALLOWS FOR REMOTE MOUNTING**  
**HIGHER LUMENS PER WATT THAN PREVIOUS MODELS**  
**IMPROVED DESIGN - MODERN & SLEEK**  
**LIGHTER WEIGHT - EASY INSTALL**  
**SINGLE QUICK CONNECT CABLE FROM FIXTURE TO DRIVER BOX**

SLIPFITTER MOUNT AVAILABLE  
 77020B - 500W FIXTURES  
 77025B - 750W FIXTURES



CAT. NO.	WATTS	BEAM ANGLE	VOLTS	LUMENS	CRI	COLOR TEMP	CASE QTY
<b>500W</b>							
77000B*	500W	30°	120-277V	71,030	70	5000K	1
77004B	500W	40°	120-277V	70,939	72	5000K	1
77006B*	500W	80°	120-277V	76,575	70	5000K	1
77001B*	500W	30°	277-480V	71,088	70	5000K	1
77005B	500W	40°	277-480V	71,377	72	5000K	1
77007B*	500W	80°	277-480V	71,377	72	5000K	1
<b>750W</b>							
77008B*	750W	20°	120-277V	117,065	70	5000K	1
77013B*	750W	30°	120-277V	106,482	70	5000K	1
77015B	750W	40°	120-277V	106,780	72	5000K	1
77017B*	750W	60°	120-277V	113,369	70	5000K	1
77038B*	750W	80°	120-277V	117,763	70	5000K	1
77009B*	750W	20°	277-480V	112,746	70	5000K	1
77014B*	750W	30°	277-480V	102,398	70	5000K	1
77016B	750W	40°	277-480V	102,744	72	5000K	1
77018B*	750W	60°	277-480V	114,948	70	5000K	1
77039B*	750W	80°	277-480V	111,752	70	5000K	1
<b>ACCESSORIES</b>							
77019	LASER AIMING DEVICE						1
77020B	SLIPFITTER MOUNT WITH BRACKET FOR USE WITH 500W FIXTURES						4
77025B	SLIPFITTER MOUNT WITH BRACKET FOR USE WITH 750W FIXTURES						1
77036B	50' REMOTE MOUNT DRIVER CABLE						10

\* NOT DLC LISTED



# HIGH POWER FLOODS

**USED FOR: SPORTS LIGHTS / ARCHITECTURAL FLOOD LIGHTS / HIGH WATT AREA LIGHTS**

**MODULAR AREA LIGHT/SPORTS LIGHT**  
**15°, 30°, 60°, 90°,**  
**TYPE II, TYPE III DISTRIBUTIONS**



**400W/500W**

SINGLE FIXTURE  
(YOKE INCLUDED)

**800W/1000W**

2 FIXTURES WITH BRACKET  
(BRACKET SOLD SEPARATELY)

**1500W**

3 FIXTURES WITH BRACKET  
(BRACKET SOLD SEPARATELY)

**400W - 1500W**

**Yoke Mount or Slipfitter**

**Multiple Beam Angles**

**120V-277V and  
200V-480V Available**

**5000K**

**DLC Premium Listed**



**77143 - SLIPFITTER  
FOR USE WITH  
400W & 500W SINGLE  
FIXTURES ONLY**

*Modular Sports Lighting*

CAT. NO.	WATTS	BEAM ANGLE	VOLTS	LUMENS	CRI	COLOR TEMP	CASE QTY
<b>400 WATT FIXTURES</b>							
77100	400W	30°	120-277V	51,390	73	5000K	1
77101	400W	15°	120-277V	55,067	73	5000K	1
77102	400W	60°	120-277V	51,989	73	5000K	1
77103	400W	90°	120-277V	55,067	73	5000K	1
77104	400W	TYPE II	120-277V	55,067	73	5000K	1
77105	400W	TYPE III	120-277V	55,067	73	5000K	1
77112	400W	30°	200-480V	50,696	73	5000K	1
77113	400W	15°	200-480V	55,067	73	5000K	1
77114	400W	60°	200-480V	53,598	73	5000K	1
77115	400W	90°	200-480V	55,067	73	5000K	1
77116	400W	TYPE II	200-480V	55,067	73	5000K	1
77117	400W	TYPE III	200-480V	55,067	73	5000K	1
<b>500 WATT FIXTURES</b>							
77106	500W	30°	120-277V	65,662	73	5000K	1
77107	500W	15°	120-277V	67,810	73	5000K	1
77108	500W	60°	120-277V	67,274	73	5000K	1
77109	500W	90°	120-277V	67,810	73	5000K	1
77110	500W	TYPE II	120-277V	67,810	73	5000K	1
77111	500W	TYPE III	120-277V	67,810	73	5000K	1
77118	500W	30°	200-480V	66,238	73	5000K	1
77119	500W	15°	200-480V	67,810	73	5000K	1
77120	500W	60°	200-480V	69,708	73	5000K	1
77121	500W	90°	200-480V	67,810	73	5000K	1
77122	500W	TYPE II	200-480V	67,810	73	5000K	1
77123	500W	TYPE III	200-480V	67,810	73	5000K	1
<b>ACCESSORIES</b>							
77135			2 FIXTURE MOUNTING BRACKET FOR 400W FIXTURES				1
77136			2 FIXTURE MOUNTING BRACKET FOR 500W FIXTURES				1
77137			3 FIXTURE MOUNTING BRACKET FOR 500W FIXTURES				1
77143			SLIPFITTER MOUNT FOR 400W & 500W SINGLE FIXTURES				1
77138			GLARE SHIELD FOR 400W FIXTURES				1
77139			GLARE SHIELD FOR 500W FIXTURES				1
77140			10' REMOTE MOUNT DRIVER CABLE				1
77141			50' REMOTE MOUNT DRIVER CABLE				1
77142			LASER AIMING DEVICE				1



# HIGH POWER FLOODS



- Compact Flat-Back Design
- Wattage and Color Selectable
- Integrated Photocell with On/Off Switch
- Slipfitter and Trunnion Mounts Sold Separately
- Wet Location Rated

## MOUNTS SOLD SEPARATELY

CAT. NO.	FIG.	WATTS	VOLTS	HOUSING COLOR	COLOR TEMP	LUMENS @ MAX WATTS	DIMMING	DIMENSIONS			CASE QTY
								H	W	D	
HPFL155	1	78/116/155W	120-277V	BRONZE	3/4/5K	25,700	0-10V	9.91"	12.55"	2.90"	2
HPFL260	2	130/195/260W	120-277V	BRONZE	3/4/5K	44,802	0-10V	12.67"	18"	3.69"	2
<b>ACCESSORIES</b>											
HPFLSF				SLIPFITTER MOUNT							12
HPFLTR				TRUNNION MOUNT							12

# ARCHITECTURAL FLOODS



FIG. 1

FIG. 2

FIG. 3

- 0-10V Dimmable
- Die-Cast Aluminum Housing
- Tempered Glass Lens

## TRUNNION MOUNT SOLD SEPARATELY - INSTALL IN FIELD

CAT. NO.	FIG.	MOUNT	WATTS	VOLTS	HOUSING COLOR	COLOR TEMP	LUMENS	DIMENSIONS			CASE QTY
								H	W	D	
71353B	1	1/2" ADJ. KNUCKLE	80W	120-277V	BRONZE	5000K	10,488	11.625"	10.75"	3.75"	1
71356B	2	2-3/8" SLIPFITTER	100W	120-277V	BRONZE	5000K	12,900	17"	14.375"	4.875"	1
71148B	2	2-3/8" SLIPFITTER	150W	120-277V	BRONZE	5000K	19,865	17"	14.375"	4.875"	1
71357B	3	2-3/8" SLIPFITTER	300W	120-277V	BRONZE	5000K	37,800	20.375"	18.75"	5.50"	1
71149B	2	2-3/8" SLIPFITTER	150W	277-480V	BRONZE	5000K	20,850	17"	14.25"	4.875"	1
71358B	3	2-3/8" SLIPFITTER	300W	277-480V	BRONZE	5000K	42,600	20.375"	18.75"	5.50"	1
<b>ACCESSORIES</b>											
75351B				100W-150W VISOR							1
75352B				300W VISOR							1
71359B				80W TRUNNION MOUNT							1
71360B				100W-300W TRUNNION MOUNT							1

PLEASE REVIEW ONLINE SPECIFICATION SHEETS. IMAGES AND CERTIFICATIONS MAY NOT BE 100% REPRESENTATIVE OF ALL PRODUCTS LISTED. TO VIEW DETAILS OF OUR DLC QUALIFIED PRODUCTS, PLEASE CONSULT THE DLC QUALIFIED PRODUCTS LIST AT [WWW.DESIGNLIGHTS.ORG/QPL](http://WWW.DESIGNLIGHTS.ORG/QPL)



# COLOR SELECTABLE SMALL FLOODS

- 0-10V Dimmable
- Voltage: 120-277V
- Integrated Photocell with On/Off Switch
- Die-Cast Aluminum Housing
- Transparent PC Lens



COLOR TEMPERATURE SELECTABLE &  
ON/OFF PHOTOCONTROL



YOKE MOUNT  
OPTION INCLUDED



KNUCKLE  
PRE-INSTALLED

CAT. NO.	WATTS	MOUNT	HOUSING COLOR	COLOR TEMP	LUMENS @ MAX WATTS	CASE QTY
71531B	15W	1/2" KNUCKLE/ YOKE	BRONZE	3000K 4000K 5000K	2,130	24
71553B	15W	1/2" KNUCKLE/ YOKE	WHITE	3000K 4000K 5000K	2,130	24
71532B	30W	1/2" KNUCKLE/ YOKE	BRONZE	3000K 4000K 5000K	4,440	12
71822B	30W	1/2" KNUCKLE/ YOKE	WHITE	3000K 4000K 5000K	4,440	12

## COLOR & WATTAGE SELECTABLE

71533B	40/50/60W	1/2" KNUCKLE/ YOKE	BRONZE	3000K 4000K 5000K	8,950	12
71823B	40/50/60W	1/2" KNUCKLE/ YOKE	WHITE	3000K 4000K 5000K	8,950	12

PLEASE REVIEW ONLINE SPECIFICATION SHEETS. IMAGES AND CERTIFICATIONS MAY NOT BE 100% REPRESENTATIVE OF ALL PRODUCTS LISTED. TO VIEW DETAILS OF OUR DLC QUALIFIED PRODUCTS, PLEASE CONSULT THE DLC QUALIFIED PRODUCTS LIST AT [WWW.DESIGNLIGHTS.ORG/QPL](http://WWW.DESIGNLIGHTS.ORG/QPL)



# BULLET FLOOD GEN 2



- Voltage: 120-277V
- 0-10V Dimming
- Die-Cast Aluminum Housing
- Tempered Glass Lens

Flood Lighting

CAT. NO.	FIG.	WATTS	COLOR TEMP	COLOR	LUMENS	BEAM ANGLE	CRI	CASE QTY
<b>FLOODS 22 WATT</b>								
71660B	I	21W	5000K	BRONZE	2,873	19°	70	6
71675B	I	21W	3000K	BRONZE	2,681	49°	70	6
71677B	I	21W	3000K	BLACK	2,681	49°	70	6
71678B	I	21W	3000K	WHITE	2,681	49°	70	6
74660	I	21W	4000K	BRONZE	2,896	49°	70	6
71679B	I	21W	5000K	BRONZE	2,894	49°	70	6
71682B	I	21W	5000K	WHITE	2,894	49°	70	6
74664	I	22W	5000K	BRONZE	2,802	78°	70	6
<b>FLOODS 40 WATT</b>								
71663B	I	40W	5000K	BRONZE	5,347	19°	71	6
71691B	I	40W	3000K	BRONZE	4,861	45°	70	6
71694B	I	40W	3000K	WHITE	4,861	45°	70	6
71693B	I	40W	3000K	BLACK	4,861	45°	70	6
74662	I	40W	4000K	BRONZE	5,341	45°	70	6
71695B	I	40W	5000K	BRONZE	5,432	45°	71	6
71698B	I	40W	5000K	WHITE	5,432	45°	71	6
71697B	I	40W	5000K	BLACK	5,432	45°	71	6
74666	I	39W	5000K	BRONZE	5,190	80°	71	6
<b>FLAGPOLE / SPOT 72 WATT</b>								
71699	2	72W	5000K	BRONZE	8,260	22°	70	4

## PVC MOUNTING POST



CAT. NO.	COLOR	POST	COLLAR	LENGTH	BOX QTY
18101	BRONZE	2.375"	2.50"	22"	12

PLEASE REVIEW ONLINE SPECIFICATION SHEETS. IMAGES AND CERTIFICATIONS MAY NOT BE 100% REPRESENTATIVE OF ALL PRODUCTS LISTED. TO VIEW DETAILS OF OUR DLC QUALIFIED PRODUCTS, PLEASE CONSULT THE DLC QUALIFIED PRODUCTS LIST AT [WWW.DESIGNLIGHTS.ORG/QPL](http://WWW.DESIGNLIGHTS.ORG/QPL)





## COLOR & WATTAGE SELECTABLE CLASSIC DUSK TO DAWN

- Aluminum Housing with Polycarbonate Clear Lens
- Twist Lock Photocell Included



CAT. NO.	MOUNTING	WATTS	VOLTS	COLOR TEMP	LUMENS	WEIGHT (LBS)	CASE QTY
71333C	ARM/WALL	36W 48W 60W	120-277V	3000K 4000K 5000K	8,537	2.8	8
71318C	ARM/WALL	72W 96W 120W	120-277V	3000K 4000K 5000K	13,870	7	4
<b>MOUNT (SOLD SEPARATELY)</b>							
71305B			MOUNTING ARM 36W-120W				1



## COLOR SELECTABLE GOOSENECKS

- Voltage: 120-277V
- 0-10V Dimmable
- On/Off Photocontrol Included
- Die-Cast Aluminum Housing with Tempered Glass Lens
- 4.9" Back Mounting Plate



**HIGHER LUMENS PER WATT THAN PREVIOUS MODELS  
REMOVABLE SHROUD**

CAT. NO.	COLOR	COLOR TEMP	WATTS	VOLTS	LUMENS	CASE QTY
75119B	BRONZE	3000K 4000K 5000K	35W	120-277V	4,824	1
75121B	BLACK	3000K 4000K 5000K	35W	120-277V	4,824	1
75123B	WHITE	3000K 4000K 5000K	35W	120-277V	4,824	1

PLEASE REVIEW ONLINE SPECIFICATION SHEETS. IMAGES AND CERTIFICATIONS MAY NOT BE 100% REPRESENTATIVE OF ALL PRODUCTS LISTED. TO VIEW DETAILS OF OUR DLC QUALIFIED PRODUCTS, PLEASE CONSULT THE DLC QUALIFIED PRODUCTS LIST AT [WWW.DESIGNLIGHTS.ORG/QPL](http://WWW.DESIGNLIGHTS.ORG/QPL)



**NEW**

# COLOR SELECTABLE SECURITY LIGHTING



FIG. 1



LAMPS ONLY  
NO MOTION SENSOR

FIG. 2



MOTION SENSOR MODES: AUTO MODE,  
DUSK TO DAWN MODE, MANUAL OVER-  
RIDE MODE, TEST MODE

- 2.5kV Surge Protection
- Easy Install: Crossbar Installation
- Die-Cast Aluminum Housing with Tempered Glass Lens

HIGHER LUMENS PER WATT THAN PREVIOUS MODELS  
INCREASED BEAM ANGLE  
TRIAC DIMMING

CAT. NO.	FIG.	DESCRIPTION	MOTION ACTIVATED	HOUSING COLOR	COLOR TEMP	WATTS	VOLTS	LUMENS	CASE QTY
72580B	1	ROUND 2 HEAD	NO	BRONZE	3000K 4000K 5000K	24W	120V	2,500	12
72581B	1	ROUND 2 HEAD	NO	WHITE	3000K 4000K 5000K	24W	120V	2,500	12
72568B	2	ROUND 2 HEAD	YES	BRONZE	3000K 4000K 5000K	24W	120V	2,500	12
72563B	2	ROUND 2 HEAD	YES	WHITE	3000K 4000K 5000K	24W	120V	2,500	12

**NEW**

## MOTION SENSOR ONLY



- Motion Sensor Modes: Auto Mode, Dusk to Dawn Mode, Manual Override Mode, Test Mode
- Detection Range: Max 180°
- Detection Distance: 5' - 60' (adjustable)
- Time Setting: 10sec. - 10min.
- Input Power: 120 VAC, 60Hz
- Load Rating: Max. 500W Incandescent lamp or Max 200W LED Driver/LED Bulb
- Operation LUX: ON to OFF Max: 800LUX  
OFF to ON 20-90LUX
- Power Consumption: Max 0.5 Watts on stand-by
- Operation Temperature: -22°F to 122°F
- Polycarbonate Enclosure
- Used With Morris Items: 72580B, 72581B

CAT. NO.	DETECTION ANGLE	HOUSING COLOR	CASE QTY
72582B	180°	BRONZE	48
72583B	180°	WHITE	48

PLEASE REVIEW ONLINE SPECIFICATION SHEETS. IMAGES AND CERTIFICATIONS MAY NOT BE 100% REPRESENTATIVE OF ALL PRODUCTS LISTED. TO VIEW DETAILS OF OUR DLC QUALIFIED PRODUCTS, PLEASE CONSULT THE DLC QUALIFIED PRODUCTS LIST AT [WWW.DESIGNLIGHTS.ORG/DPL](http://WWW.DESIGNLIGHTS.ORG/DPL)

[WWW.MORRISPRODUCTS.COM](http://WWW.MORRISPRODUCTS.COM)

1-888-777-6678



# LED PHOTOCELLS



CAT. NO.	FIG.	MOUNTING	VOLTS	ON/OFF LUX	TUNGSTEN RATING (W)	BALLAST RATING (VA)	AMPS	CASE QTY
<b>LED BUTTON STYLE</b>								
39100	1	FIXTURE	120-277V	16 LX/24 LX	1000W	1,200 @ 120V 1,800 @ 208-277V	8A @ 120V 5A @ 208-277V	160
<b>LED SHUTTER STYLE</b>								
39102	2	FIXED	120-277V	16 LX/24 LX	1000W	1,200 @ 120V 1,800 @ 208-277V	8A @ 120V 5A @ 208-277V	200
39103	2	SWIVEL	120-277V	16 LX/24 LX	1000W	1,200 @ 120V 1,800 @ 208-277V	8A @ 120V 5A @ 208-277V	100
<b>LED PENCIL STYLE</b>								
39104	3	SWIVEL	120-277V	16 LX/24 LX	1000W	1,200 @ 120V 1,800 @ 208-277V	8A @ 120V - 5A @ 208-277V	200



FIG. 1



FIG. 2



FIG. 3



# LED TWIST-LOCK STYLE PHOTOCELLS

CAT. NO.	MOUNTING	VOLTS	ON/OFF LUX	TUNGSTEN RATING (W)	BALLAST RATING (VA)	AMPS	CASE QTY
39106	TWIST LOCK	120-277V	16 LX/24 LX	1000W	1,800 @ 120V 1,800 @ 208-277V	8A @ 120V 5A @ 208-277V	100
39107	TWIST LOCK	480V	16 LX/24 LX	1800W	1,800VA	5A	100



**25,000V!**



# MECHANICAL PHOTOCONTROLS - LOCKING STYLE

## SPEC GRADE

CAT. NO.	FIG.	VOLTS	TUNGSTEN RATING (W)	BALLAST RATING (VA)	COLOR	CASE QTY
39053	1	120V	1800W	1000VA	GRAY	100
39051	2	208-277V	1800W	1000VA	MAROON	100



FIG. 1



FIG. 2

## STANDARD

CAT. NO.	FIG.	VOLTS	SURGE PROTECTION	TUNGSTEN RATING (W)	BALLAST RATING (VA)	COLOR	CASE QTY
39050	3	120V	-	1800W	1000VA	CLEAR	100
39052	4	105 - 285V	235 JOULES/5,000A 820V CLAMPING	1000W	1800VA	BLUE	100



FIG. 3



FIG. 4



# TWIST LOCK RECEPTACLES

CAT. NO.	FIG.	DESCRIPTION	CASE QTY
39070*	1	RECEPTACLE FIXTURE MOUNT - UL RECOGNIZED	100
39072	2	RECEPTACLE WITH ALUMINUM BRACKET MOUNT - UL LISTED	100

\* NOT UL LISTED



FIG. 1



FIG. 2

PLEASE REVIEW ONLINE SPECIFICATION SHEETS. IMAGES AND CERTIFICATIONS MAY NOT BE 100% REPRESENTATIVE OF ALL PRODUCTS LISTED. TO VIEW DETAILS OF OUR DLC QUALIFIED PRODUCTS, PLEASE CONSULT THE DLC QUALIFIED PRODUCTS LIST AT [WWW.DESIGNLIGHTS.ORG/DPL](http://WWW.DESIGNLIGHTS.ORG/DPL)



# MECHANICAL PHOTOCONTROLS - SHUTTER STYLE



## FIXED BASE

CAT. NO.	VOLTS	TUNGSTEN RATING (W)	BALLAST RATING (VA)	CASE QTY
39010	120V	2000W	2,000VA	100
39012	208-277V	2000W	2,000VA	100



## SWIVEL BASE

CAT. NO.	VOLTS	TUNGSTEN RATING (W)	BALLAST RATING (VA)	CASE QTY
39020	120V	2000W	2,000VA	100
39022	208-277V	2000W	2,000VA	100



## SPEC GRADE - FIXED BASE

CAT. NO.	VOLTS	TUNGSTEN RATING (W)	BALLAST RATING (VA)	LIGHT SENSOR	CASE QTY
39011	120V	3000W	3,000VA	1"	50
39013	208-277V	3000W	3,000VA	1"	50

# PHOTOCONTROLS



SWIVEL BASE

## PENCIL TYPE

CAT. NO.	VOLTS	TUNGSTEN RATING (W)	BALLAST RATING (VA)	CASE QTY
39060	120V	1800W	1,100VA	100
39062	208-277V	1800W	1,100VA	100



FIG. 1

FIG. 2

## FLUSH MOUNT

CAT. NO.	FIG.	VOLTS	TUNGSTEN RATING (W)	BALLAST RATING (VA)	CASE QTY
39030	1	120V	1800W	1,100VA	150
39032	1	208-277V	2000W	2,000VA	150

## MINI-FLUSH MOUNT

39069	2	120V	600W	480VA	150
-------	---	------	------	-------	-----

# FLUSH MOUNT WITH WALLPLATE



CAT. NO.	VOLTS	TUNGSTEN RATING (W)	BALLAST RATING (VA)	CASE QTY
39040	120V	1800W	1,100VA	100
39042	208-277V	2000W	2,000VA	100

# PHOTOCONTROL MOUNT - SWIVEL EXTENDER



CAT. NO.	DESCRIPTION	CASE QTY
39063	PHOTOCONTROL MOUNT SWIVEL EXTENDER	1

# PHOTOCONTROLS - ACCESSORIES



SHORTING CAP



OPEN CIRCUIT CAP

CAT. NO.	VOLTS	SURGE PROTECTION	TUNGSTEN RATING (W)	BALLAST RATING (VA)	COLOR	CASE QTY
39056	120V-480V	-	7200W	7,200VA	BLACK	100
39058	480V	460 JOULES/10,000A 820V CLAMPING	7200W	7,200VA	BLACK	100

CAT. NO.	VOLTAGE	COLOR	CASE QTY
39057	480V	RED	100



# LINEAR HIGH BAY AIMABLE LENS



- 0-10V Dimmable
- Emergency Backup & Motion Sensor Capable (Sold Separately)
- 180° Rotating Lens
- Triangular Suspension Mount Hooks with 3' Hang Chain Included



Linear High Bays

CAT. NO.	WATTS	VOLTS	COLOR TEMP	LUMENS	CASE QTY
71703B	50W	120-277V	5000K	7,107	1
71705B	50W	120-277V	4000K	7,029	1
71706B	110W	120-277V	5000K	15,473	1
71708B	110W	120-277V	4000K	14,976	1
71709B	165W	120-277V	5000K	22,813	1
71711B	165W	120-277V	4000K	22,742	1
71713B	220W	120-277V	5000K	30,114	1
71715B	220W	120-277V	4000K	30,114	1
71718B	255W 275W 300W	120-277V	4000K 5000K	40,729	1
71710B	165W	277-480V	5000K	22,813	1
71714B	220W	277-480V	5000K	30,114	1

## ACCESSORIES

71716B	20W EMERGENCY BATTERY BACKUP	1
74187B	MICROWAVE MOTION SENSOR - 120-277V FIXTURES	150
74186B	PIR SENSOR - 120-277V FIXTURES	150
74188B	REMOTE CONTROL - PIR AND MICROWAVE MOTION SENSORS	100
74072C	MICROWAVE MOTION SENSOR FOR 480V	100
71717A	SUSPENSION CABLE	200
71741A	SURFACE MOUNT FOR 120-277V	40

PLEASE REVIEW ONLINE SPECIFICATION SHEETS. IMAGES AND CERTIFICATIONS MAY NOT BE 100% REPRESENTATIVE OF ALL PRODUCTS LISTED. TO VIEW DETAILS OF OUR DLC QUALIFIED PRODUCTS, PLEASE CONSULT THE DLC QUALIFIED PRODUCTS LIST AT [WWW.DESIGNLIGHTS.ORG/QPL](http://WWW.DESIGNLIGHTS.ORG/QPL)



# COLOR & WATTAGE SELECTABLE UFO HIGHBAYS

**NEW**

**DIMMABLE**  
0-10V

**DLC**  
LISTED

**UL**  
LISTED



- Corrosion Resistant Die-Cast Aluminum Housing
- ½" Thread Hook Mount Included
- IP65 Rated

CAT. NO.	FIG.	WATTS	COLOR TEMP	VOLTS	HOUSING COLOR	LUMENS @ MAX WATTS	LUMENS/WATT	DIMMING	CASE QTY
UAPI50	1	80W 100W 150W	3000K 4000K 5000K	120-277V	BLACK	23,600	165	0-10V	1
UAP200	2	120W 150W 200W	3000K 4000K 5000K	120-277V	BLACK	31,500	165	0-10V	1
UAP240	2	150W 200W 240W	3000K 4000K 5000K	120-277V	BLACK	38,300	165	0-10V	1
<b>ACCESSORIES</b>									
76503				40W UFO LINE SIDE EMERGENCY BATTERY BACKUP					4
76504				REMOTE TESTER FOR #76503					50

## UFO LINE SIDE EMERGENCY BATTERY BACKUP



120V AC (170V DC Line Side Wiring)

No load side DC wiring necessary - **FAST & SIMPLE**  
Remote Tester for periodic battery testing - works with multiple units



CAT. NO.	WATTS	CASE QTY
76503	40W	4
76504	REMOTE TESTER	50

PLEASE REVIEW ONLINE SPECIFICATION SHEETS. IMAGES AND CERTIFICATIONS MAY NOT BE 100% REPRESENTATIVE OF ALL PRODUCTS LISTED. TO VIEW DETAILS OF OUR DLC QUALIFIED PRODUCTS, PLEASE CONSULT THE DLC QUALIFIED PRODUCTS LIST AT [WWW.DESIGNLIGHTS.ORG/QPL](http://WWW.DESIGNLIGHTS.ORG/QPL)

[WWW.MORRISPRODUCTS.COM](http://WWW.MORRISPRODUCTS.COM)

1-888-777-6678

UFO High Bays



# SPECIFICATION GRADE UFO

- 6KV Surge Protection
- IP65 Wet Location Rated
- Emergency Battery Backup Available



FIG. 1



FIG. 2



FIG. 3

120-277V PLUG-&-PLAY  
CENTER MOUNT MOTION SENSOR  
EMERGENCY BATTERY BACKUP AVAILABLE

CAT. NO.	FIG.	WATTS	COLOR TEMP	VOLTS	HOUSING COLOR	LUMENS	DIMMING	CASE QTY
74100B	1	100W	5000K	120-277V	BLACK	14,680	1-10V	1
74101B		100W	4000K	120-277V	BLACK	14,796	0-10V	1
74101C		100W	4000K	120-277V	BLACK	14,116	0-10V	1
74297C	2	100W 120W 150W	3000K 4000K 5000K	120-277V	BLACK	22,086	0-10V	1
74198C	2	100W 120W 150W	3000K 4000K 5000K	120-277V	WHITE	22,086	0-10V	1
74102B	1	150W	5000K	120-277V	BLACK	20,893	1-10V	1
74095B		150W	4000K	120-277V	BLACK	20,881	1-10V	1
74095C	2	150W	4000K	120-277V	BLACK	21,096	0-10V	1
74199	3	160W 200W 240W	3000K 4000K 5000K	120-277V	WHITE	33,740	1-10V	1
74104B	1	200W	5000K	120-277V	BLACK	29,079	0-10V	1
74214	1	200W	5000K	120-277V	WHITE	29,079	0-10V	1
74094B		200W	4000K	120-277V	BLACK	29,112	1-10V	1
74094C	2	200W	4000K	120-277V	BLACK	27,981	0-10V	1
74106B	1	240W	5000K	120-277V	BLACK	33,747	1-10V	1
74106C		240W	5000K	120-277V	BLACK	38,190	0-10V	1
74093B	1	240W	4000K	120-277V	BLACK	34,016	1-10V	1
74103C	2	160W 200W 240W	5000K	277-480V	BLACK	33,981	0-10V	1

## SPECIFICATION GRADE UFO ACCESSORIES



FIG. 1 FIG. 2 FIG. 3 FIG. 4 FIG. 5 FIG. 6 FIG. 7 FIG. 8 FIG. 9 FIG. 10 FIG. 11 FIG. 12

**SPEC GRADE ACCESSORIES WORK WITH THE SINGLE COLOR AND COLOR SELECTABLE SPEC GRADE FIXTURES**

CAT. NO.	FIG.	DESCRIPTION	CASE QTY
74143	1	1/2" - 3/4" NPT CONDUIT ADAPTOR	1
74187B	2	MICROWAVE MOTION SENSOR - 120-277V FIXTURES	150
74072C	3	MICROWAVE MOTION SENSOR - 480V FIXTURES	100
74186B	4	PIR SENSOR - 120-277V FIXTURES	150
74188B	5	REMOTE CONTROL - PIR AND MICROWAVE MOTION SENSORS	100
76503	6	EMERGENCY BATTERY BACKUP - 120-277V ONLY	1
76504	7	REMOTE CONTROL - EMERGENCY BATTERY BACKUP	1
74110B	8	BLACK U-BRACKET - 100W-150W FIXTURES	20
74112B	8	BLACK U-BRACKET - 200W-240W FIXTURES	20
74135C	9	WIRE GUARD - 100W-150W FIXTURES	20
74137C	9	WIRE GUARD - 200W-240W FIXTURES	20
74119B	10	90° ALUMINUM REFLECTOR - 100W-150W FIXTURES	20
74121B	10	90° ALUMINUM REFLECTOR - 200W-240W FIXTURES	20
74123B	11	90° PC REFLECTOR - 100W-150W FIXTURES	1
74149B	12	90° PC BOTTOM COVER - 100W-150W FIXTURES	1
74125B	11	90° PC REFLECTOR - 200W-240W FIXTURES	1
74152B	12	90° PC BOTTOM COVER - 200W-240W FIXTURES	1



# COLOR & WATTAGE SELECTABLE PANEL LIGHTS



- 0-10V Dimming
- Backlit Panel
- Mounting Accessories & Emergency Battery Backup Available

CAT. NO.	SIZE	COLOR TEMP	FIXTURE HEIGHT	WATTS	VOLTS	LUMENS @ MAX WATTS	LM/W	DIMMING	ORDER IN MULTIPLES
<b>3500K - 5000K CCT &amp; WATTAGE SELECTABLE DLC PREMIUM</b>									
71164D	2'X2'	3500K 4000K 5000K	1.625"	20W 30W 35W	120-277V	4,313	125	0-10V	4
71165D	2'X4'	3500K 4000K 5000K	1.625"	25W 35W 40W	120-277V	5,228	131	0-10V	4
<b>ACCESSORIES</b>									
76501	15W EMERGENCY BATTERY BACKUP FOR 71164D - EXTERNAL MOUNT ONLY								10
76502	25W EMERGENCY BATTERY BACKUP FOR 71165D - EXTERNAL MOUNT ONLY								10
71797B	SURFACE MOUNT KIT FOR 2'X2' PANELS								10
71799D	SURFACE MOUNT KIT FOR 2'X4' PANELS								10

# COLOR & WATTAGE SELECTABLE TROFFERS



- Surface Mount
- 0-10V Dimming

CAT. NO.	SIZE	COLOR TEMP	WATTS RANGE	VOLTS	LUMENS @ MAX WATTS	LM/W	DIMMING	ORDER IN MULTIPLES	
71789C	2'X2'	3500K 4000K 5000K	20W 25W 30W	120-277V	3,811	132	0-10V	2	
71784C	2'X4'	3500K 4000K 5000K	34W 38W 45W	120-277V	6,268	138	0-10V	2	
<b>ACCESSORIES</b>									
76501	15W EMERGENCY BATTERY BACKUP FOR 71789C - EXTERNAL MOUNT ONLY								10
76502	25W EMERGENCY BATTERY BACKUP FOR 71784C - EXTERNAL MOUNT ONLY								10
71797B	SURFACE MOUNT KIT FOR 2'X2' TROFFERS								10
71799D	SURFACE MOUNT KIT FOR 2'X4' TROFFERS								10

PLEASE REVIEW ONLINE SPECIFICATION SHEETS. IMAGES AND CERTIFICATIONS MAY NOT BE 100% REPRESENTATIVE OF ALL PRODUCTS LISTED. TO VIEW DETAILS OF OUR DLC QUALIFIED PRODUCTS, PLEASE CONSULT THE DLC QUALIFIED PRODUCTS LIST AT [WWW.DESIGNLIGHTS.ORG/QPL](http://WWW.DESIGNLIGHTS.ORG/QPL)





# COLOR SELECTABLE LED CLASSIC STRIPLIGHT



- Surface Mount
- 0-10V Dimming



CAT. NO.	LENGTH	COLOR TEMP	WATTS	VOLTS	LUMENS	CRI	CASE QTY
71914A*	2'	3500K 4000K 5000K	20W	120-277V	3,125	82	10
71913B	4'	3500K 4000K 5000K	22W 28W 40W	120-277V	5,317	82	6

### ACCESSORIES

71729B	MICROWAVE MOTION SENSOR	1
71769A	MICROWAVE MOTION SENSOR REMOTE CONTROL	1
76501	15W EMERGENCY BATTERY BACKUP FOR 71914A - EXTERNAL MOUNT ONLY	10
76502	25W EMERGENCY BATTERY BACKUP FOR 71913B - INTERNAL OR EXTERNAL MOUNT	10

\* NOT DLC LISTED



## LINE SIDE EMERGENCY BATTERY BACKUP

- For use with Linear High Bays, Panels, Troffers, Strips, Wraps & Vaportight Fixtures
- 120V AC (170V DC Line Side Wiring)
- No load side DC wiring necessary - **FAST & SIMPLE**



CAT. NO.	WATTS	CASE QTY
76501	15	10
76502	25	10

PLEASE REVIEW ONLINE SPECIFICATION SHEETS. IMAGES AND CERTIFICATIONS MAY NOT BE 100% REPRESENTATIVE OF ALL PRODUCTS LISTED. TO VIEW DETAILS OF OUR DLC QUALIFIED PRODUCTS, PLEASE CONSULT THE DLC QUALIFIED PRODUCTS LIST AT [WWW.DESIGNLIGHTS.ORG/DPL](http://WWW.DESIGNLIGHTS.ORG/DPL)

[WWW.MORRISPRODUCTS.COM](http://WWW.MORRISPRODUCTS.COM)

1-888-777-6678



# COLOR SELECTABLE LED LINEAR VAPORTIGHT



- 0-10V Dimmable
- Compatible with most LED dimmers
- Polycarbonate Housing & Stainless Steel Hasp
- IP65 Rated

CAT. NO.	LENGTH	COLOR TEMP	WATTS	VOLTS	LUMENS @MAX WATTS	CRI	CASE QTY
71900B	2'	3500K, 4000K, 5000K	25W	120-277V	3,375	80	6
71901B	4'	3500K, 4000K, 5000K	40W	120-277V	5,400	80	6

### ACCESSORIES

76501	15W EMERGENCY BATTERY BACKUP FOR 71900B - EXTERNAL MOUNT ONLY						10
76502	25W EMERGENCY BATTERY BACKUP FOR 71901B - INTERNAL OR EXTERNAL MOUNT						10
71729B	EXTERNAL MICROWAVE MOTION SENSOR - 4' ONLY						1
71769A	EXTERNAL MICROWAVE MOTION SENSOR CONTROLLER - 4' ONLY						1

# LED VAPORTIGHT JELLY JARS



FIG. 1



FIG. 2

- Die Cast Aluminum Housing
- Wall or Ceiling Mount
- Threaded Apertures: (4)Sides (1)Top/Back
- IP65 Rated

CAT. NO.	FIG.	WATTS	VOLTS	LUMENS	MOUNT	WEIGHT (LBS)	CASE QTY
72105A	1	11W	120-277V	1,112	CEILING	1.8	6
72107A	1	23W	120-277V	2,632	CEILING	1.9	6
72108A	2	23W	120-277V	2,632	WALL	2.6	6

# LED LINEAR SHOPLIGHT



- Steel Housing - Corrosion Resistant Finish
- Polycarbonate Frosted Lens
- Linkable:  
40W - up to 8 fixtures  
23W - up to 12 fixtures
- On/Off Pull Chain

CAT. NO.	LENGTH	COLOR TEMP	WATTS	VOLTS	LUMENS	CRI	LINKABLE	CASE QTY
71946A	4'	5000K	40W	120V	4,006	83	YES	8

PLEASE REVIEW ONLINE SPECIFICATION SHEETS. IMAGES AND CERTIFICATIONS MAY NOT BE 100% REPRESENTATIVE OF ALL PRODUCTS LISTED. TO VIEW DETAILS OF OUR DLC QUALIFIED PRODUCTS, PLEASE CONSULT THE DLC QUALIFIED PRODUCTS LIST AT [WWW.DESIGNLIGHTS.ORG/QPL](http://WWW.DESIGNLIGHTS.ORG/QPL)



# LED CLASSIC LINEAR WRAP

- 0-10V Dimmable
- Heavy Gauge Steel Housing
- PMMA Frosted Diffuser
- IP23 Rated for Damp Location



CAT. NO.	LENGTH	COLOR TEMP	WATTS	VOLTS	LUMENS	CRI	CASE QTY
71942A*	2'	5000K	25W	120-277V	3,000	83	1
71943A*	2'	4000K	25W	120-277V	3,000	83	1
71940A	4'	5000K	40W	120-277V	4,800	83	1
71941A	4'	4000K	40W	120-277V	4,800	83	1
<b>ACCESSORIES</b>							
71729B	MICROWAVE MOTION SENSOR						1
71769A	REMOTE CONTROL FOR MICROWAVE MOTION SENSOR						1
76501	15W EMERGENCY BATTERY BACKUP FOR 71942A & 71943A - EXTERNAL MOUNT ONLY						10
76502	25W EMERGENCY BATTERY BACKUP FOR 71940A & 71941A - EXTERNAL MOUNT ONLY						10

\*NOT DLC LISTED



# ECONOMY WRAP

- 0-10V Dimmable
- Heavy Gauge Steel Housing
- PMMA Frosted Diffuser
- IP20 Rated



CAT. NO.	LENGTH	COLOR TEMP	WATTS	VOLTS	LUMENS	CRI	CASE QTY
71974	4'	5000K	40W	120-277V	4,852	83	4
71975	4'	4000K	40W	120-277V	4,875	81	4
<b>ACCESSORIES</b>							
76502	25W EMERGENCY BATTERY BACKUP - EXTERNAL MOUNT ONLY						10



# COLOR SELECTABLE LED CLASSIC LINEAR WRAP

- 0-10V Dimmable
- Heavy Gauge Steel Housing
- PMMA Frosted Diffuser
- IP40 Rated



CAT. NO.	LENGTH	COLOR TEMP	WATTS	VOLTS	LUMENS	CRI	CASE QTY
71944A	4'	3500K 4000K 5000K	40W	120-277V	4,800	83	1
<b>ACCESSORIES</b>							
71729B	MICROWAVE MOTION SENSOR						1
71769A	REMOTE CONTROL FOR MICROWAVE MOTION SENSOR						1
76502	25W EMERGENCY BATTERY BACKUP - EXTERNAL MOUNT ONLY						10

PLEASE REVIEW ONLINE SPECIFICATION SHEETS. IMAGES AND CERTIFICATIONS MAY NOT BE 100% REPRESENTATIVE OF ALL PRODUCTS LISTED. TO VIEW DETAILS OF OUR DLC QUALIFIED PRODUCTS, PLEASE CONSULT THE DLC QUALIFIED PRODUCTS LIST AT [WWW.DESIGNLIGHTS.ORG/QPL](http://WWW.DESIGNLIGHTS.ORG/QPL)



# LED DESIGNER LINEAR ARC WRAP



- 0-10V Dimmable
- Heavy Gauge Steel Housing
- Polycarbonate Frosted Diffuser
- IP20 Rated

CAT. NO.	LUMENS	LENGTH	WATTS	COLOR TEMP	VOLTS	DIMENSIONS			CASE QTY
						L	W	H	
71931A	4,800	4'	40W	5000K	120-277V	48"	4.75"	2.875"	6
<b>ACCESSORIES</b>									
76502	25W EMERGENCY BATTERY BACKUP - EXTERNAL MOUNT ONLY								10
71933	4' REFLECTORS - SET OF 2								6

## COLOR & WATTAGE SELECTABLE

# ARCHITECTURAL LINEAR ARC WRAP



- 0-10V Dimmable
- Aluminum Housing
- Polycarbonate Frosted Lens
- IP20 Rated

CAT. NO.	SIZE	COLOR TEMP	WATTS	VOLTS	LUMENS @ MAX WATTS	BEAM ANGLE	LM/W	CRI	CASE QTY
71945A	4'	3500K 4000K 5000K	32W 40W 45W	120-277V	6,012	120°	120	82	1
<b>ACCESSORIES</b>									
71948A	SUSPENSION KIT - 1 SET								1
71729B	EXTERNAL MICROWAVE MOTION SENSOR								1
71769A	EXTERNAL MICROWAVE MOTION SENSOR CONTROLLER								1
71915A	10W EMERGENCY BATTERY BACKUP								1
71720A	6' WIRING WHIP								1

PLEASE REVIEW ONLINE SPECIFICATION SHEETS. IMAGES AND CERTIFICATIONS MAY NOT BE 100% REPRESENTATIVE OF ALL PRODUCTS LISTED. TO VIEW DETAILS OF OUR DLC QUALIFIED PRODUCTS, PLEASE CONSULT THE DLC QUALIFIED PRODUCTS LIST AT [WWW.DESIGNLIGHTS.ORG/QPL](http://WWW.DESIGNLIGHTS.ORG/QPL)

# LOOP CABLE GRIPS SECONDARY RETENTION

CAT. NO.	FIG.	DESCRIPTION	BAG QTY
17200	1	SMALL LOOP CABLE GRIP 1/16" - 5/64" 110LB TENSILE	10
17201	2	MEDIUM LOOP CABLE GRIP 3/32" - 1/8" 250LB TENSILE	10
17202	3	LARGE LOOP CABLE GRIP 3/16" 660LB TENSILE	5



FIG. 1



FIG. 2



FIG. 3

# MINI/SMALL LOOP CABLE GRIPS

CAT. NO.	FIG.	DESCRIPTION	BAG QTY
17203	1	MINI LOOP CABLE GRIP WITH LOOPED WIRE ROPE - 3/64" - 1/16" X 10" 66LB TENSILE	1 KIT
17204	2	MINI LOOP CABLE GRIP WITH STUD END WIRE ROPE - 3/64" - 1/16" X 10" 66LB TENSILE	1 KIT
17205	3	MINI LOOP CABLE GRIP WITH Y LOOPED WIRE ROPE - 3/64" - 1/16" X 1" 66LB TENSILE	1 KIT
17206	4	SMALL LOOP CABLE GRIP WITH LOOPED WIRE ROPE - 5/64" - 1/16" X 10" 110LB TENSILE	1 KIT



FIG. 1



FIG. 2



FIG. 3



FIG. 4

# MINI/SMALL LOOP CABLE GRIP

CAT. NO.	DESCRIPTION	BAG QTY
17208	WIRE ROPE WITH HALF BALL END STOP 1/16" X 60" 66LB TENSILE	10



# WIRE ROPE HANGERS

CAT. NO.	FIG.	DESCRIPTION	TENSILE STRENGTH/ LBS	CASE QTY
17211	1	WIRE ROPE LOOPED END 1/16" X 60"	66	100
17212	1	WIRE ROPE LOOPED END 5/64" X 60"	110	100
17213	1	WIRE ROPE LOOPED END 1/8" X 60"	250	100
17215	2	WIRE ROPE WITH TOGGLE 1/16" X 60"	66	100
17216	2	WIRE ROPE WITH TOGGLE 5/64" X 60"	110	100
17218	3	WIRE ROPE WITH Y TOGGLE 1/16" X 60"	66	400
17221	4	WIRE ROPE WITH V TOGGLE 1/16" X 60"	66	400
17224	5	WIRE ROPE WITH V HOOK & BLOCKER 1/16" X 60"	66	600
17227	6	WIRE ROPE WITH STUD 1/16" X 12"	66	400
17228	6	WIRE ROPE WITH STUD 60" X 1/8"	250	400
17229	7	WIRE ROPE ROLL 1/16"	66	50
17230	7	WIRE ROPE ROLL 1/8" X 500'	250	50



FIG. 1

FIG. 2

FIG. 3



FIG. 4



FIG. 5



FIG. 6



FIG. 7



PLEASE REVIEW ONLINE SPECIFICATION SHEETS. IMAGES AND CERTIFICATIONS MAY NOT BE 100% REPRESENTATIVE OF ALL PRODUCTS LISTED. TO VIEW DETAILS OF OUR DLC QUALIFIED PRODUCTS, PLEASE CONSULT THE DLC QUALIFIED PRODUCTS LIST AT [WWW.DESIGNLIGHTS.ORG/QPL](http://WWW.DESIGNLIGHTS.ORG/QPL)



# COLOR SELECTABLE

# WAFER DOWNLIGHTS



SMOOTH



72786B FRAME KIT FOR 4" & 6" WAFERS



BAFFLE

- 120° Beam Angle
- Remote Driver
- IC Rated for Direct Contact with Insulation

## TRIAC DIMMING

CAT. NO.	TRIM STYLE	SIZE	COLOR TEMP	WATTS	VOLTS	LUMENS	CRI	ENERGY STAR	CASE QTY
<b>NEW</b> 72680C	SMOOTH	4"	2700K, 3000K, 3500K, 4000K, 5000K	9W	120V	760	90	2025 V1.0	24
72682B	SMOOTH	6"	2700K, 3000K, 3500K, 4000K, 5000K	12W	120V	1,000	80	2024	24
<b>NEW</b> 72783C	SMOOTH	8"	2700K, 3000K, 3500K, 4000K, 5000K	12W	120V	1,440	90	2025 V1.0	24
72785B	BAFFLE	6"	2700K, 3000K, 3500K, 4000K, 5000K	12W	120V	1,000	80	2024	24
<b>ACCESSORIES</b>									
72786B	FRAME KIT FOR 4" & 6" WAFER DOWNLIGHTS								24

# COLOR & WATTAGE SELECTABLE

# NEW CONSTRUCTION DOWNLIGHTS



- Perfect for Residential or Commercial Applications
- Spring Action Housing Clips

## 0-10V DIMMING

CAT. NO.	TRIM STYLE	SIZE	COLOR TEMP	WATTS	VOLTS	LUMENS @ MAX WATTS	CRI	ENERGY STAR	CASE QTY
72638B	BAFFLE	6"	2700K, 3000K, 3500K, 4000K, 5000K	12W 17W 22W	120-277V	2,194	90	2024	12
<b>NEW</b> 72639C	BAFFLE	8"	2700K, 3000K, 3500K, 4000K, 5000K	17W 24W 30W	120-277V	3,273	90	2025 V1.0	12

PLEASE REVIEW ONLINE SPECIFICATION SHEETS. IMAGES AND CERTIFICATIONS MAY NOT BE 100% REPRESENTATIVE OF ALL PRODUCTS LISTED. TO VIEW DETAILS OF OUR DLC QUALIFIED PRODUCTS, PLEASE CONSULT THE DLC QUALIFIED PRODUCTS LIST AT [WWW.DESIGNLIGHTS.ORG/QPL](http://WWW.DESIGNLIGHTS.ORG/QPL)



## COLOR SELECTABLE DOWNLIGHT WITH JUNCTION BOX

- Includes Integrated Junction Box
- TRIAC Dimming Compatible with Most LED Dimmers
- Operating Temperature: -4°F to 113°F
- Wet Indoor Location Rated
- IC Rated for Direct Contact with Insulation



### TRIAC DIMMING

CAT. NO.	SIZE	TRIM STYLE	COLOR TEMP	WATTS	LUMENS	VOLTS	CRI	BEAM ANGLE	CASE QTY
72643B	6"	BAFFLE	2700K, 3000K, 3500K, 4000K, 5000K	15W	1,135	120-277V	90	100°	24

Surface Mount Downlighting



## COLOR SELECTABLE SURFACE MOUNT RETROFIT DOWNLIGHTS WITH MOTION SENSOR

- Motion Sensor Included
- Suitable for use in closets when installed in accordance with NEC requirements
- Auto turn-off time selectable



**ENERGY STAR 2025 V1.0 LISTED  
HIGHER LUMENS PER WATT THAN  
PREVIOUS MODELS**

### TRIAC DIMMING

CAT. NO.	SIZE	WATTS	VOLTS	COLOR TEMP	LUMENS	CRI	CASE QTY
72740C	6"	15W	120V	2700K, 3000K, 3500K, 4000K, 5000K	1,230	90	24

PLEASE REVIEW ONLINE SPECIFICATION SHEETS. IMAGES AND CERTIFICATIONS MAY NOT BE 100% REPRESENTATIVE OF ALL PRODUCTS LISTED. TO VIEW DETAILS OF OUR DLC QUALIFIED PRODUCTS, PLEASE CONSULT THE DLC QUALIFIED PRODUCTS LIST AT [WWW.DESIGNLIGHTS.ORG/QPL](http://WWW.DESIGNLIGHTS.ORG/QPL)





# COLOR SELECTABLE RETROFIT DOWNLIGHTS



- Easy Clip-in to Existing Can Housing
- Baffle/Smooth Finish Option
- Emits Evenly – No Halo or Shadows

## TRIAC DIMMING

CAT. NO.	TRIM STYLE	SIZE	COLOR TEMP	WATTS	VOLTS	LUMENS	CRI	ENERGY STAR	CASE QTY
72761B	BAFFLE	4"	2700K, 3000K, 3500K, 4000K, 5000K	10W	120V	752	90	2024	60
 72762C	BAFFLE	6"	2700K, 3000K, 3500K, 4000K, 5000K	15W	120V	1,250	90	2025 V1.0	24
 72763C	SMOOTH	4"	2700K, 3000K, 3500K, 4000K, 5000K	10W	120V	850	90	2025 V1.0	60
 72764C	SMOOTH	6"	2700K, 3000K, 3500K, 4000K, 5000K	15W	120V	1,250	90	2025 V1.0	24

# COLOR SELECTABLE GIMBAL RECESSED LIGHTING RETROFIT KIT



- 60° Lens Tilt for Specific Spotlighting
- 360° Horizontal Swivel of Lens

## TRIAC DIMMING

CAT. NO.	SIZE	WATTS	VOLTS	COLOR TEMP	LUMENS	CRI	CASE QTY
72620B	4"	10W	120V	2700K, 3000K, 3500K, 4000K, 5000K	720	90	24
72623B	6"	15W	120V	2700K, 3000K, 3500K, 4000K, 5000K	1,168	90	24

PLEASE REVIEW ONLINE SPECIFICATION SHEETS. IMAGES AND CERTIFICATIONS MAY NOT BE 100% REPRESENTATIVE OF ALL PRODUCTS LISTED. TO VIEW DETAILS OF OUR DLC QUALIFIED PRODUCTS, PLEASE CONSULT THE DLC QUALIFIED PRODUCTS LIST AT [WWW.DESIGNLIGHTS.ORG/DPL](http://WWW.DESIGNLIGHTS.ORG/DPL)





# RETROFIT HI-BAY LAMP



Retrofit Lighting

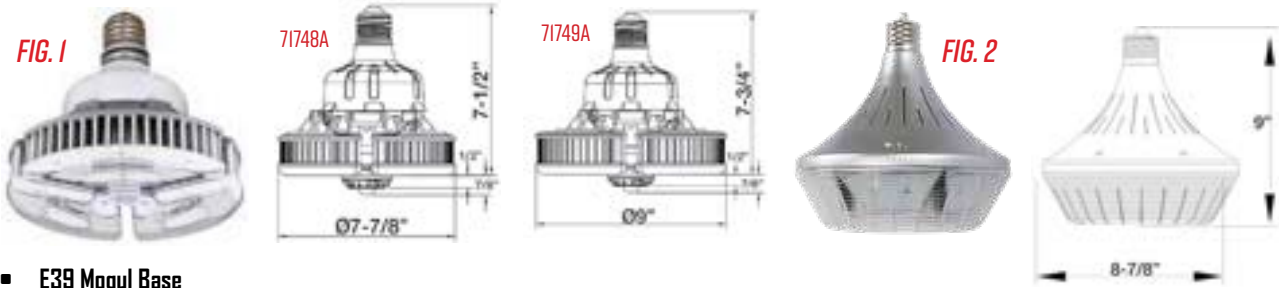

- E39 Mogul Base
- Retrofit for HPS & MH Hi-Bay Lamps
- Input Voltage: 120-277VAC

CAT. NO.	FIG.	WATTS	VOLTS	LUMENS	COLOR TEMP	WEIGHT (LBS)	CASE QTY
71748A	1	80W	120-277V	10,609	5000K	3.2	4
71749A	1	120W	120-277V	16,099	5000K	3.7	4
70621	2	155W	120-277V	19,098	5000K	4.4	6
70622	2	240W	120-277V	31,200	5000K	3.5	4



# RETROFIT HIGH BAY LAMP

- Adjustable Paddle Style Panels
- Commercial Hi-Bay Applications
- Adjustable Beam Angle: 0° to 90°
- Aluminum Housing
- Polycarbonate Lens



CAT. NO.	BASE	WATTS	VOLTS	LUMENS	COLOR TEMP	WEIGHT (LBS)	CASE QTY
70623	E26	100W	120-277V	15,000	5000K	4.4	6
70624	E39	150W	120-277V	18,000	5000K	3.5	4



# RETROFIT GARAGE & WORKSHOP LAMP

- Adjustable Paddle Style Panels
- Shop & Garage Low Bay Applications
- Adjustable Beam Angle: 0° to 90°
- E26 Base
- Aluminum Housing
- Polycarbonate Lens



CAT. NO.	WATTS	VOLTS	LUMENS	COLOR TEMP	WEIGHT (LBS)	CASE QTY
70625	50W	120-277V	6,000	5000K	4.4	6
70626	100W	120-277V	12,000	5000K	3.5	4

PLEASE REVIEW ONLINE SPECIFICATION SHEETS. IMAGES AND CERTIFICATIONS MAY NOT BE 100% REPRESENTATIVE OF ALL PRODUCTS LISTED. TO VIEW DETAILS OF OUR DLC QUALIFIED PRODUCTS, PLEASE CONSULT THE DLC QUALIFIED PRODUCTS LIST AT [WWW.DESIGNLIGHTS.ORG/QPL](http://WWW.DESIGNLIGHTS.ORG/QPL)



# WATTAGE SELECTABLE GENERAL PURPOSE RETROFIT LAMP



- E26 or E39 Base
- Polycarbonate Housing
- Polycarbonate Diffused Lens
- 70604B/705605B are Color Selectable
- IP64 Wet Location Rated

CAT. NO.	WATTS	VOLTS	BASE TYPE	PARTIAL CUTOFF	LUMENS	REPLACES METAL HALIDE	COLOR TEMP	LENGTH	DIAMETER	CASE QTY
70601B*	25W/36W	120-277V	E26	NO	4,450	100W	5000K	8.75"	2.375"	24
70618B*	32W/45W	120-277V	E26	NO	5,535	150W	5000K	9"	3.375"	24
70602B*	42W/60W	120-277V	E26	NO	7,516	175W	5000K	9.25"	3.50"	12
70620B	42W/60W	120-277V	E39	NO	7,516	175W	5000K	9.25"	3.50"	12
70604B	70W/100W	120-277V	E39	NO	11,746 @ 4K	400W	4K/5K	11.875"	3.50"	12
70605B	84W/120W	120-277V	E39	NO	14,404 @ 4K	500W	4K/5K	11.50"	4.50"	6

\*NOT DLC LISTED

# AREA LIGHT/SHOEBOX RETROFIT LAMP

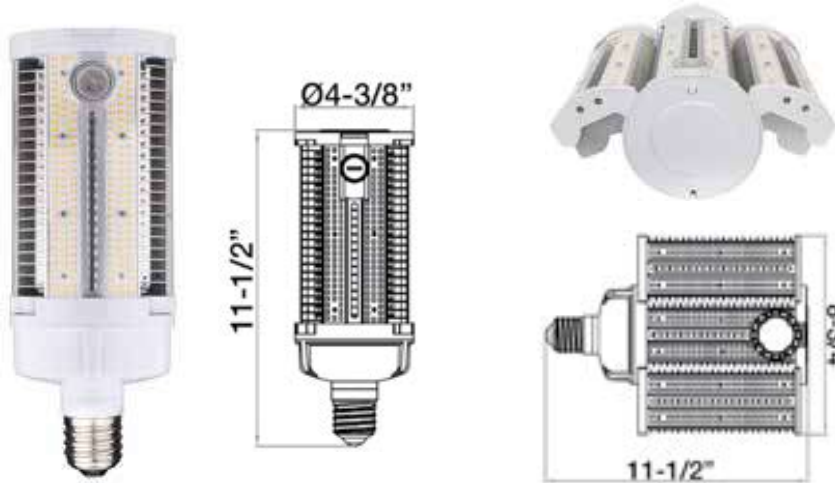

- E39 Mogul Base
- Aluminum Housing
- Polycarbonate Diffused Lens
- IP65 Wet Location Rated

CAT. NO.	FIG.	WATTS	VOLTS	COLOR TEMP	LUMENS	WEIGHT (LBS)	CASE QTY
70617A	I	110W	120-277V	5000K	12,911	3.4	6



# E39 TO E26 BASE ADAPTOR

CAT. NO.	APPLICATION	WEIGHT (LBS)	CASE QTY
71879	CONVERT E39 BASE TO E26 BASE	I	50

PLEASE REVIEW ONLINE SPECIFICATION SHEETS. IMAGES AND CERTIFICATIONS MAY NOT BE 100% REPRESENTATIVE OF ALL PRODUCTS LISTED. TO VIEW DETAILS OF OUR DLC QUALIFIED PRODUCTS, PLEASE CONSULT THE DLC QUALIFIED PRODUCTS LIST AT [WWW.DESIGNLIGHTS.ORG/QPL](http://WWW.DESIGNLIGHTS.ORG/QPL)

[WWW.MORRISPRODUCTS.COM](http://WWW.MORRISPRODUCTS.COM)

1-888-777-6678



# COLOR SELECTABLE 120V UNDERCABINET LIGHTING



- Internal Wiring Compartment
- Integral On/Off Switch
- Grounded Receptacle
- Beam Angle: 120°
- Linkable - Jump Cords Sold Separately
- TRIAC Dimmable
- Powder Coated Steel Housing - PC Lens



Undercabinet

CAT. NO.	LENGTH	COLOR	COLOR TEMP	TYPE	WATTS	VOLTS	LUMENS	WIDTH	HEIGHT	CASE QTY	
71251A	9"	WHITE	3000K 4000K	HARD WIRE	5W	120V	270	3.5"	1"	4	
71252A	12"	WHITE	3000K 4000K	HARD WIRE	5W	120V	270	3.5"	1"	4	
71260A	18"	WHITE	3000K 4000K	HARD WIRE	9W	120V	460	3.5"	1"	4	
<b>ACCESSORIES</b>											
71265					6" JUMPER CORD						12
71266					12" JUMPER CORD						12
71267					24" JUMPER CORD						12
71268					36" JUMPER CORD						12
71273					48" JUMPER CORD						12

PLEASE REVIEW ONLINE SPECIFICATION SHEETS. IMAGES AND CERTIFICATIONS MAY NOT BE 100% REPRESENTATIVE OF ALL PRODUCTS LISTED. TO VIEW DETAILS OF OUR DLC QUALIFIED PRODUCTS, PLEASE CONSULT THE DLC QUALIFIED PRODUCTS LIST AT [WWW.DESIGNLIGHTS.ORG/QPL](http://WWW.DESIGNLIGHTS.ORG/QPL)



# LED DIMMERS 12V/24V DC



- LED Compatible
- 12V or 24V DC
- PWM DIMMING
- Decorative PC Housing & Face
- MOV Surge Suppression



FIG. 1 FIG. 2 FIG. 3 FIG. 4

CAT. NO.	FIG.	VOLTS (DC)	FUNCTIONS	SWITCH RATING	LED/CFL WATTS	FLUORESCENT WATTS	CASE QTY
82840	1	12/24V	SLIDE/ON/OFF SWITCH	1P	60W	NO	10/60
82841	1	12/24V	SLIDE/ON/OFF SWITCH	3 WAY	60W	NO	10/60
82842	2	12/24V	SLIDE	1P	60W	NO	10/60
82843	2	12/24V	SLIDE	3 WAY	60W	NO	10/60
82844	2	12/24V	SLIDE	1P	100W	NO	10/60
82845	3	12/24V	DUAL SLIDE	2P	60W PER POLE	NO	10/60
82860	4	12/24V	ROCKER	1P	60W	NO	10/60
82861	4	12/24V	ROCKER	3 WAY	60W	NO	10/60
82850	4	12/24V	ROCKER	3 WAY	100W	NO	10/60

# LED DIMMERS 120VAC



- LED Compatible
- 120V
- TRIAC Dimming
- Full Range Dimming
- MOV Surge Suppression
- Decorative PC Housing
- ETL Listed



FIG. 1 FIG. 2 FIG. 3 FIG. 4 FIG. 5

CAT. NO.	FIG.	VOLTS	FUNCTIONS	SWITCH RATING	LED/CFL WATTS	FLUORESCENT WATTS	MICRO CONTROLLER	SENSITIVITY ADJ DIAL	CASE QTY
82859	1	120V	SLIDE/ON/OFF SWITCH	1 POLE	150	700	NO	YES	10/60
82846	1	120V	SLIDE/ON/OFF SWITCH	3 WAY	150	700	NO	YES	10/60
82847	2	120V	ROCKER	1 POLE	150	600	NO	NO	10/60
82848	2	120V	ROCKER	3 WAY	150	600	NO	NO	10/60
82862	2	120V	ROCKER	1 POLE	150	700	NO	YES	10/60
82863	3	120V	ROCKER	1 POLE	150	600	YES	NO	10/60
82853	3	120V	ROCKER	3 WAY	150	600	YES	NO	10/60
82864	4	120V	SLIDE/ON/OFF SWITCH	1 POLE	150	600	YES	NO	10/60
82865	4	120V	SLIDE/ON/OFF SWITCH	3 WAY	150	600	YES	NO	10/60
82855	5	120V	SLIDE/ROCKER	1 POLE/3 WAY	150	700	NO	YES	10/60

# LED DIMMERS 120VAC 0-10V DIMMING



- LED Compatible
- 0-10V Dimming
- 120/277V
- LED, CFL & Electronic Self Ballasted Applications
- MOV Surge Suppression
- Decorative PC Housing
- Adjustable High End/Low End Trim Sensitivity Dial to Optimize Dimming



FIG. 1 FIG. 2 FIG. 3

CAT. NO.	FIG.	VOLTS	FUNCTIONS	SWITCH RATING	LED/CFL WATTS	INCANDESCENT WATTS	AMPS	CASE QTY
82851	1	120/277V	ROCKER	1P/3 WAY	150W	600W	3A @120V; 1A @ 277V	60
82852	2	120/277V	ROCKER	1P/3 WAY	150W	600W	6A @120V; 3A @ 277V	60
82854	3	120/277V	ROCKER	1P/3 WAY	150W	600W	6A @120V; 3A @ 277V	60



# DIMMER WITH MOTION SENSOR



- PIR Motion Sensor
- Sensitivity, Light Level and Time Delay Settings
- Resistive: 3A
- Motor: 1/8 HP
- 180° Coverage
- 1200 Sq Ft Area
- LED, CFL & Electronic Self Ballasted Applications
- Operating Temperature: -4°F To 140°F
- LED Compatible
- MOV Surge Suppression
- Decorative PC Housing



CAT. NO.	VOLTS	DIMMING	SWITCH RATING	LED/CFL WATTS	BALLAST WATTS	CASE QTY
82656	120-277V	0-10V	1P	150W	800W	10/60
82657	120V	0-120V	1P	150W	800W	10/60



# DUAL SLIDE FAN SPEED AND LIGHT CONTROLS

- LED Compatible
- Fan Control: 3 Speed or Fully Variable
- Light Control: Fully Variable
- 120V
- LED, CFL & Electronic Self Ballasted Applications
- Operating Temperature: 32°F To 104°F
- Material: PC Housing and Face Plate



CAT. NO.	VOLTS	FUNCTIONS	SWITCH RATING	CURRENT RATING	LED WATTS	INCANDESCENT/HALOGEN WATTS	CASE QTY
82654	120V	3 SPEED	1P	5A	150W	360W	10/60
82655	120V	FULL VARIABLE	1P	2.5A	150W	360W	10/60



# SLIDE FAN SPEED CONTROL

- Fan Control: 3 Speed
- 120V
- Operating Temperature: 32°F To 104°F
- Material: PC Housing and Face Plate



CAT. NO.	VOLTS	FUNCTIONS	SWITCH RATING	CURRENT RATING	CASE QTY
82664	120V	SLIDE SWITCH	1P	2.5A	10/60

PLEASE REVIEW ONLINE SPECIFICATION SHEETS. IMAGES AND CERTIFICATIONS MAY NOT BE 100% REPRESENTATIVE OF ALL PRODUCTS LISTED. TO VIEW DETAILS OF OUR DLC QUALIFIED PRODUCTS, PLEASE CONSULT THE DLC QUALIFIED PRODUCTS LIST AT [WWW.DESIGNLIGHTS.ORG/QPL](http://WWW.DESIGNLIGHTS.ORG/QPL)



# WALL MOUNT OCCUPANCY/VACANCY SENSOR



Occupancy Sensors

## PIR



CAT. NO.	COLOR	SWITCH TYPE	SWITCH RATING	INCANDESCENT/FLUORESCENT RATING	COVERAGE	VOLTS	LED WATTS	TIME DELAY	CASE QTY
80520	IVORY	AUTO ON/OFF MANUAL ON/AUTO OFF	SINGLE POLE	800W @ 120V 1200W @ 277V	180°	120-277V	300W	5 SEC-30 MIN	50
80521	WHITE	AUTO ON/OFF MANUAL ON/AUTO OFF	SINGLE POLE	800W @ 120V 1200W @ 277V	180°	120-277V	300W	5 SEC-30 MIN	50
80540	WHITE	AUTO ON/OFF MANUAL ON/AUTO OFF	SINGLE POLE 3-WAY	800W @ 120V 1200W @ 277V	180°	120-277V	300W	5 SEC-30 MIN	50

## NO NEUTRAL - PIR



CAT. NO.	COLOR	SWITCH TYPE	SWITCH RATING	INCANDESCENT/FLUORESCENT RATING	COVERAGE	VOLTS	LED WATTS	TIME DELAY	CASE QTY
80528	WHITE	AUTO ON/OFF MANUAL ON/AUTO OFF	SINGLE POLE	800W @ 120V 1200W @ 277V	180°	120-277V	300W	5 SEC-30 MIN	50
80532	WHITE	AUTO ON/OFF MANUAL ON/AUTO OFF	SINGLE POLE 3-WAY	800W @ 120V 1200W @ 277V	180°	120-277V	300W	5 SEC-30 MIN	50

## DOUBLE POLE - PIR



CAT. NO.	COLOR	SWITCH TYPE	SWITCH RATING	INCANDESCENT/FLUORESCENT RATING	COVERAGE	VOLTS	LED WATTS	CASE QTY
80544	WHITE	ON/OFF AUTO MANUAL ON/AUTO OFF	DOUBLE POLE	800W @ 120V	180°	120V	150W	50
80548	WHITE	ON/OFF AUTO MANUAL ON/AUTO OFF	DOUBLE POLE	800W @ 120V 1200W @ 277V	180°	120-277V	150W	50

# MOTION SENSOR SWITCH - PIR



FIG. 1  
CEILING



FIG. 2  
HI-BAY

CAT. NO.	FIG.	COLOR	INCANDESCENT/FLUORESCENT RATING	COVERAGE	VOLTS	CASE QTY
80552	1	WHITE	800W @ 120V, 1200W @ 277V	360°, 20' DIAMETER @ 15' HEIGHT, 15' DIAMETER @ 10' HEIGHT	120-277V	50
80556	2	WHITE	800W @ 120V, 1200W @ 277V	360° - 30' HEIGHT & 40' DIAMETER	120-277V	50

PLEASE REVIEW ONLINE SPECIFICATION SHEETS. IMAGES AND CERTIFICATIONS MAY NOT BE 100% REPRESENTATIVE OF ALL PRODUCTS LISTED. TO VIEW DETAILS OF OUR DLC QUALIFIED PRODUCTS, PLEASE CONSULT THE DLC QUALIFIED PRODUCTS LIST AT [WWW.DESIGNLIGHTS.ORG/QPL](http://WWW.DESIGNLIGHTS.ORG/QPL)



# LED FIBERGLASS LAMPHOLDERS WITH LAMP



- LED & GU24 Lampholder
- Polycarbonate Cover
- Twist Lock Mounting
- GU24 Base
- Fits 3-1/4" or 4" Outlet Box
- Lamp Included
- 9 Watts
- 800 Lumens
- 4-1/2" Outside Diameter
- 7" Leads
- Input Voltage: 120V



CAT. NO.	DESCRIPTION	WATTS	VOLTS	LUMENS	DIMENSIONS				CASE QTY
					A	B	C	D	
72530	KEYLESS	9W	120V	800	3-1/16"	3-1/2"	1-1/2"	4-1/2"	24
72531	PULL CHAIN	9W	120V	800	3-1/16"	3-7/8"	1-1/4"	5"	48
72532	GU24 LED	9W	120V	800	2-1/2"	1-1/16"	-	3-1/8"	48

## FIXTURE HOOK

CAT. NO.	THREAD SIZE	CASE QTY
18092	3/4"	50



## TOMBSTONE LED & T8

CAT. NO.	STYLE	VOLTAGE	BAG QTY
<b>LOW PROFILE</b>			
45225	NON-SHUNTED	600V	10
45227	SHUNTED	1000V	10
<b>TALL PROFILE</b>			
45226	NON-SHUNTED	600V	10
45228	SHUNTED	1000V	10

- Medium Bi-Pin Fluorescent
- Slide-On with Captive Nut
- Push Wire Terminations
- 660W



## 7 DAY IN-WALL

## DIGITAL SELF-ADJUSTING TIMER - SUNTRACKER

CAT. NO.	COLOR	SUNTRACKER	CASE QTY
80510	IVORY	NO	6
80511	WHITE	NO	6
80515	IVORY	YES	6
80516	WHITE	YES	6

SUNTRACKER & DAYLIGHT SAVINGS FEATURES



## IN-WALL COUNTDOWN TIMER

CAT. NO.	COLOR	CASE QTY
80505	WHITE	6



PLEASE REVIEW ONLINE SPECIFICATION SHEETS. IMAGES AND CERTIFICATIONS MAY NOT BE 100% REPRESENTATIVE OF ALL PRODUCTS LISTED. TO VIEW DETAILS OF OUR DLC QUALIFIED PRODUCTS, PLEASE CONSULT THE DLC QUALIFIED PRODUCTS LIST AT [WWW.DESIGNLIGHTS.ORG/QPL](http://WWW.DESIGNLIGHTS.ORG/QPL)



# LED EXIT SIGNS



CAT. NO.	LED COLOR	HOUSING COLOR	VOLTS	BATTERY BACKUP	CASE QTY
<b>STANDARD</b>					
73010	RED	WHITE	120/277V	NO	6
73012	RED	WHITE	120/277V	YES	6
73013	RED	BLACK	120/277V	YES	6
73014	GREEN	WHITE	120/277V	NO	6
73016	GREEN	WHITE	120/277V	YES	6
73017	GREEN	BLACK	120/277V	YES	6
<b>REMOTE CAPABLE (USE ONLY 3.6V LED REMOTE HEADS)</b>					
73022	RED	WHITE	120/277V	YES	6
73024	GREEN	WHITE	120/277V	YES	6
73025	GREEN	BLACK	120/277V	YES	6
<b>2 CIRCUIT UNIT WIRED FOR AC POWER &amp; DC GENERATOR BACKUP</b>					
73026	RED	WHITE	120/277V	NO	6
<b>STANDARD WITH SELF DIAGNOSTIC</b>					
73512	RED	WHITE	120/277V	YES	6
73514	GREEN	WHITE	120/277V	YES	6
<b>REMOTE CAPABLE WITH SELF DIAGNOSTIC (USE ONLY 3.6V LED REMOTE HEADS) (WILL NOT OPERATE CORRECTLY UNLESS USED WITH REMOTE HEADS)</b>					
73516	RED	WHITE	120/277V	YES	6
73518	GREEN	WHITE	120/277V	YES	6

CAT. NO.	LETTER COLOR	HOUSING FINISH	VOLTS	FACE COLOR	CASE QTY
73340	RED	BRUSHED ALUMINUM	120/277V	BRUSHED ALUMINUM	6
73343	RED	BLACK	120/277V	BRUSHED ALUMINUM	6
73344	RED	BLACK	120/277V	BLACK	6
73346	RED	WHITE	120/277V	BRUSHED ALUMINUM	6
73348	RED	WHITE	120/277V	WHITE	6
73360	GREEN	BRUSHED ALUMINUM	120/277V	BRUSHED ALUMINUM	6
73363	GREEN	BLACK	120/277V	BRUSHED ALUMINUM	6
73364	GREEN	BLACK	120/277V	BLACK	6
73366	GREEN	WHITE	120/277V	BRUSHED ALUMINUM	6
<b>EXTRA FACE PLATES</b>					
73380	RED	BRUSHED ALUMINUM			1
73381	RED	BLACK			1
73382	RED	WHITE			1
73383	GREEN	BRUSHED ALUMINUM			1
73384	GREEN	BLACK			1
73385	GREEN	WHITE			1

Exit Signs

# EDGE LIT EXIT SIGNS



## SURFACE MOUNT



CEILING MOUNT



SIDE MOUNT



WALL MOUNT

To Convert Single Sided Fixture to Double Sided Legend:

- 73320 Red Double Sided Legend Panel
- 73322 Green Double Sided Legend Panel

CAT. NO.	PANEL COLOR	VOLTS	HOUSING	CASE QTY
<b>SURFACE MOUNT ONE SIDED LEGEND</b>				
73310	RED ON CLEAR	120/277V	ANODIZED ALUMINUM	4
73311	RED ON CLEAR	120/277V	WHITE	4
73312	RED ON CLEAR	120/277V	BLACK	4
73315	GREEN ON CLEAR	120/277V	ANODIZED ALUMINUM	4
73316	GREEN ON CLEAR	120/277V	WHITE	4
73317	GREEN ON CLEAR	120/277V	BLACK	4
<b>SURFACE MOUNT DOUBLE SIDED LEGEND</b>				
73402*	RED ON CLEAR	120/277V	ANODIZED ALUMINUM	4
73403*	RED ON CLEAR	120/277V	WHITE	4
73404*	RED ON CLEAR	120/277V	BLACK	4
73405*	GREEN ON CLEAR	120/277V	ANODIZED ALUMINUM	4
73406*	GREEN ON CLEAR	120/277V	WHITE	4
73407*	GREEN ON CLEAR	120/277V	BLACK	4
<b>DOUBLE SIDED PANELS</b>				
73320	RED DOUBLE SIDED PANEL			8
73322	GREEN DOUBLE SIDED PANEL			8

## RECESSED MOUNT



To Convert Single Sided Fixture to Double Sided Legend:  
73320 Red Double Sided Legend Panel  
73322 Green Double Sided Legend Panel

CAT. NO.	PANEL COLOR	VOLTS	HOUSING	CASE QTY
<b>RECESSED MOUNT ONE SIDED LEGEND</b>				
73330	RED ON CLEAR	120/277V	ANODIZED ALUMINUM	4
73331	RED ON CLEAR	120/277V	WHITE	4
73332	RED ON CLEAR	120/277V	BLACK	4
73335	GREEN ON CLEAR	120/277V	ANODIZED ALUMINUM	4
73336	GREEN ON CLEAR	120/277V	WHITE	4
73337	GREEN ON CLEAR	120/277V	BLACK	4
<b>RECESSED MOUNT DOUBLE SIDED LEGEND</b>				
73412*	RED ON CLEAR	120/277V	ANODIZED ALUMINUM	4
73413*	RED ON CLEAR	120/277V	WHITE	4
73415*	GREEN ON CLEAR	120/277V	ANODIZED ALUMINUM	4
73416*	GREEN ON CLEAR	120/277V	WHITE	4
73417*	GREEN ON CLEAR	120/277V	BLACK	4
<b>DOUBLE SIDED PANELS</b>				
73320	RED DOUBLE SIDED PANEL			8
73322	GREEN DOUBLE SIDED PANEL			8

\* Double Sided fixtures have a Mylar separator in center so you only see EXIT from one side

\* Double Sided fixtures have a Mylar separator in center so you only see EXIT from one side





## OUTDOOR COLD WEATHER & WET LOCATION

CAT. NO.	LED COLOR	VOLTS	HOUSING	CASE QTY
73386	RED	120/277V	WHITE	6
73387	RED	120/277V	BLACK	6
73388	GREEN	120/277V	WHITE	6
73389	GREEN	120/277V	BLACK	6
<b>COLD WEATHER SELF DIAGNOSTIC</b>				
73371	RED	120/277V	WHITE	6
<b>BLANK BACK MOUNTING PLATE (ONE SIDED APPLICATIONS-SOLD SEPARATELY)</b>				
73378		BLANK PLATE - WHITE		1
73379		BLANK PLATE - BLACK		1



2 LEGEND PLATES INCLUDED  
BLANK MOUNTING PLATE  
SOLD SEPARATELY



## OUTDOOR COLD WEATHER & WET LOCATION COMBO SURFACE MOUNT

CAT. NO.	LETTER COLOR	VOLTS	LUMENS PER HEAD	HOUSING COLOR	CASE QTY
<b>FIXTURES INCLUDE TWO LEGEND PLATES</b>					
73375	RED	120/277V	219	WHITE	4
<b>REMOTE CAPABLE</b>					
73376	RED	120/277V	219	WHITE	4
73369	RED	120/277V	219	BLACK	4
<b>BLANK BACK MOUNTING PLATE (ONE SIDED APPLICATIONS-SOLD SEPARATELY)</b>					
73378			BLANK PLATE - WHITE		1
73379			BLANK PLATE - BLACK		1



## OUTDOOR COLD WEATHER WET LOCATION LED EMERGENCY REMOTE CAPABLE

CAT. NO.	HOUSING	VOLTS	BATTERY	CASE QTY
73370	POLY-CARBONATE	120/277V	9.6V 1900 MAH NI-CAD	4



## INDOOR LED EMERGENCY LIGHTS WET LOCATION

CAT. NO.	VOLTS	BATTERY	CASE QTY
73396A	120/277V	NICKEL CADMIUM	4



## INDOOR LED COMBO EXIT/EMERGENCY LIGHT WET LOCATION

CAT. NO.	LED COLOR	VOLTS	BATTERY	DIMENSIONS			CASE QTY
				LENGTH	DEPTH	HEIGHT	
<b>STANDARD EXIT SIGN</b>							
73452	RED	120/277V	2.4V 500MAH NI-CD	12-5/8"	2-1/2"	8-1/8"	4
73453	GREEN	120/277V	2.4V 500MAH NI-CD	12-5/8"	2-1/2"	8-1/8"	4
<b>REMOTE CAPABLE EXIT SIGN</b>							
73454	RED	120/277V	3.6V 1800MAH NI-MH	12-5/8"	2-1/2"	8-1/8"	4
<b>STANDARD COMBO HIGH OUTPUT</b>							
73456	RED	120/277V	3.6V 1000MAH NI-CD	12-9/16"	2-1/2"	13-5/16"	4
73457	GREEN	120/277V	3.6V 1000MAH NI-CD	12-9/16"	2-1/2"	13-5/16"	4
<b>REMOTE CAPABLE COMBO HIGH OUTPUT</b>							
73458	RED	120/277V	3.6V 1800MAH NI-MH	12-9/16"	2-1/2"	13-5/16"	4





# LIGHT PIPE LED COMBO



CAT. NO.	LED COLOR	VOLTS	HOUSING	LUMENS	DIMENSIONS			CASE QTY
					WIDTH	DEPTH	HEIGHT	
73372	RED	120/277V	WHITE	184	12.50"	1.87"	8.25"	6
73373	GREEN	120/277V	WHITE	184	12.50"	1.87"	8.25"	6
<b>SELF DIAGNOSTIC</b>								
73374	RED	120/277V	WHITE	184	12.50"	1.87"	8.25"	6

# LED COMBO EXIT/EMERGENCY LIGHT

ADJUSTABLE HEADS



CAT. NO.	LED COLOR	VOLTS	HOUSING COLOR	LUMENS PER HEAD	LISTING	DIMENSIONS			CASE QTY
						WIDTH	DEPTH	HEIGHT	
<b>HIGH OUTPUT COMBO</b>									
73462	RED	120/277V	WHITE	76	cULus	20"	2"	8.10"	4
<b>HIGH OUTPUT REMOTE CAPABLE COMBO (USE ONLY LED REMOTE HEADS)</b>									
73466	RED	120/277V	WHITE	76	cULus	20"	2"	8.10"	4
<b>HIGH OUTPUT COMBO WITH SELF DIAGNOSTIC</b>									
73470	RED	120/277V	WHITE	76	cULus	20"	2"	8.10"	4
73472	GREEN	120/277V	WHITE	76	cULus	20"	2"	8.10"	4
<b>HIGH OUTPUT REMOTE CAPABLE COMBO WITH SELF DIAGNOSTIC (USE ONLY LED REMOTE HEADS) (WILL NOT OPERATE CORRECTLY UNLESS USED WITH REMOTE HEADS)</b>									
73474	RED	120/277V	WHITE	76	UL	20"	2"	8.10"	4
73476	GREEN	120/277V	WHITE	76	UL	20"	2"	8.10"	4

# LED COMBO EXIT/EMERGENCY LIGHT

ROUND HEAD



CAT. NO.	LED COLOR	VOLTS	HOUSING COLOR	LUMENS PER HEAD	DIMENSIONS			CASE QTY
					WIDTH	DEPTH	HEIGHT	
<b>STANDARD</b>								
73040	RED	120/277V	WHITE	33	11.60"	2.00"	7.20"	6
73041	RED	120/277V	BLACK	33	11.60"	2.00"	7.20"	6
73042	GREEN	120/277V	WHITE	33	11.60"	2.00"	7.20"	6
73043	GREEN	120/277V	BLACK	33	11.60"	2.00"	7.20"	6
<b>HIGH OUTPUT</b>								
73050	RED	120/277V	WHITE	76	11.60"	2.00"	7.20"	6
73052	GREEN	120/277V	WHITE	76	11.60"	2.00"	7.20"	6
<b>HIGH OUTPUT REMOTE CAPABLE (USE ONLY LED REMOTE HEADS)</b>								
73054	RED	120/277V	WHITE	76	11.60"	2.00"	7.20"	6
73055	RED	120/277V	BLACK	76	11.60"	2.00"	7.20"	6
73056	GREEN	120/277V	WHITE	76	11.60"	2.00"	7.20"	6
73057	GREEN	120/277V	BLACK	76	11.60"	2.00"	7.20"	6
<b>HIGH OUTPUT REMOTE CAPABLE WITH SELF DIAGNOSTIC (USE ONLY LED REMOTE HEADS) (WILL NOT OPERATE CORRECTLY UNLESS USED WITH REMOTE HEADS)</b>								
73538	GREEN	120/277V	WHITE	76	11.60"	2.00"	7.20"	6

# LED COMBO EXIT/EMERGENCY LIGHT

SQUARE HEAD



CAT. NO.	LED COLOR	VOLTS	HOUSING COLOR	LUMENS PER HEAD	DIMENSIONS			CASE QTY
					WIDTH	DEPTH	HEIGHT	
<b>HIGH OUTPUT</b>								
73432	RED	120/277V	WHITE	76	11.60"	1.75"	7.20"	6
73433	RED	120/277V	BLACK	76	11.60"	1.75"	7.20"	6
73434	GREEN	120/277V	WHITE	76	11.60"	1.75"	7.20"	6
73435	GREEN	120/277V	BLACK	76	11.60"	1.75"	7.20"	6
<b>HIGH OUTPUT REMOTE CAPABLE (USE ONLY LED REMOTE HEADS)</b>								
73442	RED	120/277V	WHITE	76	11.60"	1.75"	7.20"	6
73443	RED	120/277V	BLACK	76	11.60"	1.75"	7.20"	6
73444	GREEN	120/277V	WHITE	76	11.60"	1.75"	7.20"	6



## LED EMERGENCY LIGHT ROUND HEAD

CAT. NO.	COLOR	VOLTS	LUMENS PER HEAD	LISTING	DIMENSIONS			CASE QTY
					WIDTH	DEPTH	HEIGHT	
<b>STANDARD</b>								
73118	WHITE	120/277V	33	cULus	9"	2.75"	4-3/4"	12
73119	BLACK	120/277V	33	cULus	9"	2.75"	4-3/4"	12
<b>HIGH OUTPUT</b>								
73112	WHITE	120/277V	76	cULus	9"	2.75"	4-3/4"	12
<b>HIGH OUTPUT REMOTE CAPABLE (USE ONLY LED REMOTE HEADS)</b>								
73114	WHITE	120/277V	76	cULus	9"	2.75"	4-3/4"	12
73115	BLACK	120/277V	76	cULus	9"	2.75"	4-3/4"	12
<b>STANDARD WITH SELF DIAGNOSTIC</b>								
73522	WHITE	120/277V	33	UL	9"	2.75"	4-3/4"	12
<b>HIGH OUTPUT REMOTE CAPABLE WITH SELF DIAGNOSTIC (USE ONLY LED HEADS) (WILL NOT OPERATE CORRECTLY UNLESS USED WITH REMOTE HEADS)</b>								
73524	WHITE	120/277V	76	UL	9"	2.75"	4-3/4"	12



**SELF-DIAGNOSTIC VERSION MONITORS  
BATTERY/CHARGER FAILURE,  
BATTERY DISCONNECT AND LAMP FAILURE**



## LED EMERGENCY LIGHT SQUARE HEAD

CAT. NO.	COLOR	VOLTS	LUMENS PER HEAD	DIMENSIONS			CASE QTY
				WIDTH	DEPTH	HEIGHT	
<b>HIGH OUTPUT</b>							
73424	WHITE	120/277V	76	9"	2.75"	4-3/4"	9
73425	BLACK	120/277V	76	9"	2.75"	4-3/4"	9
<b>HIGH OUTPUT REMOTE CAPABLE (USE ONLY LED REMOTE HEADS)</b>							
73426	WHITE	120/277V	76	9"	2.75"	4-3/4"	9
73427	BLACK	120/277V	76	9"	2.75"	4-3/4"	9



## LED EMERGENCY LIGHT ADJUSTABLE OPTICS

CAT. NO.	COLOR	VOLTS	LUMENS PER HEAD	DIMENSIONS			CASE QTY
				WIDTH	DEPTH	HEIGHT	
73428	WHITE	120/277V	65	9.5"	2.25"	4-5/8"	12
73429	BLACK	120/277V	65	9.5"	2.25"	4-5/8"	12



## WET LOCATION ADJUSTABLE LED EMERGENCY LIGHT

CAT. NO.	VOLTS	HOUSING	CASE QTY
73398	120/277V	WHITE	6



## ADJUSTABLE LED EMERGENCY LIGHT

CAT. NO.	COLOR	VOLTS	CASE QTY
73158	WHITE	120/277V	6

**RECESSED EMERGENCY LIGHTING  
UNIT MOUNTS FLUSH  
WITH CEILING FOR A CONCEALED,  
UNOBTRUSIVE LOOK**





# NEW HI-CAPACITY EMERGENCY LIGHTS



**NOW WITH HIGH POWERED LED LAMPS  
HIGHER REMOTE CAPACITY**

**12 VOLT  
REMOTE CAPABILITY, EFFICIENT AND EASY TO INSTALL  
COMPLETELY SELF-CONTAINED & FULLY-AUTOMATIC**

CAT. NO.	WATTS PER UNIT	VOLTS	REMOTE LOAD IN MAXIMUM FOR 4 HRS	REMOTE LOAD IN MAXIMUM FOR 2 HRS	REMOTE LOAD IN MAXIMUM FOR 1.5 HRS	CASE QTY
<b>12-VOLT UNITS WITH REMOTE CAPACITY 9 WATT WEDGE BASE LAMPS</b>						
73176A	50W	120/277V	6.5W	25.5W	38W	2
73180A	100W	120/277V	25.5W	63W	88W	2

Use Multi-Volt Remote Heads at bottom of page

## LED EMERGENCY EGRESS

**AC SECURITY LIGHTING  
DUSK TO DAWN  
EMERGENCY EGRESS**



CAT. NO.	COLD WEATHER	WATTS	VOLTS	TITLE 24	LUMENS	CASE QTY
73300	NO	12W	120/277V	NO	1,286	6
73301	YES	12W	120/277V	NO	1,286	6
73302	YES	12W	120/277V	YES	1,286	6

## LED REMOTE LAMP HEADS



**FIG. 1      FIG. 2      FIG. 3      FIG. 4      FIG. 5      FIG. 6**

CAT. NO.	FIG.	DESCRIPTION	DIMENSIONS			VOLTS	WATTS	LUMEN PER HEAD	CASE QTY
			W	D	G				
73074	1	SINGLE HEAD	4.53"	4.53"	5.79"	3.6V	1.17W	76	20
73075	2	DOUBLE HEAD	7.38"	4.53"	6.53"	3.6V	2.34W	76	10
73116	3	SINGLE HEAD	4.5"	2.75"	4.5"	3.6V	1.72W	76	24
73117	4	DOUBLE HEAD	6.5"	2.75"	4.75"	3.6V	3.4W	76	10
73126	5	SINGLE HEAD WEATHERPROOF	4.53"	4.53"	5.79"	3.6V	1.17W	76	20
73127	6	DOUBLE HEAD WEATHERPROOF	7.38"	4.53"	6.53"	3.6V	2.34W	76	10

## LED MULTI-VOLT REMOTE LAMP HEADS

**3.6V/6V/9.6V/12V CAN BE USED WITH 6V/12V INCANDESCENT FIXTURES**



**FIG. 1      FIG. 2**



**FIG. 3      FIG. 4**

CAT. NO.	FIG.	DESCRIPTION	DIMENSIONS			COLOR	WATTS	LUMEN PER HEAD	CASE QTY
			W	D	G				
<b>MULTI-VOLT LAMP HEADS 3.6V/6V/9.6V/12V</b>									
73303	1	SINGLE HEAD	4.5"	2.75"	4.5"	WHITE	1W	45	12
73304	2	DOUBLE HEAD	6.5"	2.75"	4.75"	WHITE	2W	45	12
73305	3	SINGLE HEAD WEATHERPROOF	4.53"	4.53"	5.79"	GRAY	1W	45	12
73306	4	DOUBLE HEAD WEATHERPROOF	7.38"	4.53"	6.53"	GRAY	2W	45	12



# VANDAL/ENVIRONMENTAL SHIELD GUARD

POLYCARBONATE



CAT. NO.	FOR USE WITH	DIMENSIONS			CASE QTY
		HEIGHT	WIDTH	DEPTH	
73090	EXIT LIGHTS & CAST ALUMINUM EXIT LIGHTS	9"	13.25"	2.50"	16
73091	EMERGENCY LIGHTS			7" X 8.5" X 19.5"	3



## WIRE GUARDS

CAT. NO.	FOR USE WITH	DIMENSIONS			CASE QTY
		HEIGHT	WIDTH	DEPTH	
73095	EMERGENCY LIGHTS, EXIT LIGHTS & CAST ALUMINUM EXIT LIGHTS	13.5"	15"	6"	10
73096	COMBO EXIT/EMERGENCY LIGHTS	13.5"	30"	6"	5



## FLUORESCENT EMERGENCY LIGHTING BALLASTS



FIG. 1



FIG. 2



FIG. 3

CAT. NO.	FIG.	LUMENS	LAMP TYPE	LAMP LENGTH	NO. OF LAMPS	WATTAGE	INPUT WATTAGE	VOLTS	DIMENSIONS			CASE QTY
									LENGTH	WIDTH	HEIGHT	
72900	1	500	T8-T12	2' - 4'	1	17-40W	2.5	120/277V	94"	24"	1.5"	6
72901	2	300-650	2 PIN CFL	N/A	1	10-26W	3.5	120/277V	94"	24"	1.5"	6
72903	1	700	T8-T12	2' - 8'	1 OR 2	17-110W	3.5	120/277V	94"	24"	1.5"	6
72904	1	1,400	T8-T12	2' - 8'	1 OR 2	17-215W	4.0	120/277V	13.3"	24"	1.5"	6

CAT. NO.	FIG.	LUMENS	LAMP TYPE	LAMP LENGTH	NO. OF LAMPS	WATTAGE 1 LAMP	WATTAGE 2 LAMP	INPUT WATTAGE	VOLTS	DIMENSIONS			CASE QTY
										LENGTH	WIDTH	HEIGHT	
72910	3	500	T5-T8	2' - 4'	1	28W	N/A	2.5	120/277V	10"	2"	1"	6
72913	3	700	T5-T8	2' - 4'	1 OR 2	14-54WW	14-39	3.32/3.78	120/277V	13.8"	2"	1"	6



# MEETS NYC AND CHICAGO CODE REQUIREMENTS

## LED CHICAGO CODE EXIT SIGN



CAT. NO.	LED COLOR	VOLTS	HOUSING	DIMENSIONS			CASE QTY
				WIDTH	DEPTH	HEIGHT	
<b>STANDARD EXIT - AC ONLY</b>							
73611	RED	120/277V	WHITE - STEEL	10.9"	3"	16.01"	10
<b>STANDARD EXIT WITH BATTERY BACKUP</b>							
73612	RED	120/277V	WHITE - STEEL	10.9"	3"	16.01"	10

## LED CHICAGO CODE EXIT/EMERGENCY SIGN



CAT. NO.	LED COLOR	VOLTS	HOUSING	DIMENSIONS			CASE QTY
				WIDTH	DEPTH	HEIGHT	
73613	RED	120/277V	WHITE - STEEL	10.9"	3"	16.01"	4

## CHICAGO GLASS LEGEND PLATES



73620

73621

73625

73622

73623

73624

CAT. NO.	DESCRIPTION	CASE QTY
73620	EXIT - LEFT ARROW	1
73621	EXIT - RIGHT ARROW	1
73625	EXIT - NO ARROW	1
73622	STAIRS - LEFT ARROW	1
73623	STAIRS - RIGHT ARROW	1
73624	STAIRS - NO ARROW	1



## **NEW** LED CHICAGO CODE EMERGENCY LIGHT



CAT. NO.	VOLTS	HOUSING	DIMENSIONS			CASE QTY
			WIDTH	DEPTH	HEIGHT	
73615	100/300V	WHITE - STEEL	12.3"	2.4"	4.8"	4

## LED NEW YORK CITY CODE EXIT SIGN



CAT. NO.	LED COLOR	VOLTS	HOUSING	DIMENSIONS			CASE QTY
				WIDTH	DEPTH	HEIGHT	
<b>STANDARD EXIT - AC ONLY</b>							
73601	RED	120/277V	WHITE - STEEL	14.5"	2.25"	10.5"	10
<b>STANDARD EXIT WITH BATTERY BACKUP</b>							
73602	RED	120/277V	WHITE - STEEL	14.5"	2.25"	10.5"	10

## LED NEW YORK CITY CODE EXIT/EMERGENCY SIGN

**OPTIONAL 3RD HEAD INCLUDED**



CAT. NO.	LED COLOR	VOLTS	HOUSING	DIMENSIONS			CASE QTY
				WIDTH	DEPTH	HEIGHT	
73604	RED	120/277V	WHITE - STEEL	16.875"	2.5"	16.8"	4

## LED NEW YORK CITY CODE EMERGENCY LIGHT



CAT. NO.	VOLTS	HOUSING	DIMENSIONS			CASE QTY
			WIDTH	DEPTH	HEIGHT	
73603	120/277V	WHITE - STEEL	13.3125"	2.1875"	13.5"	6

Code Compliant



**WE'VE DISCOUNTED  
PREVIOUS MODELS  
TO MAKE ROOM FOR  
OUR NEW OFFERING**

**SINGLE SOURCE...  
ELECTRICAL & LIGHTING**

**CHECK OUT THE CLEARANCE CATALOG  
ON OUR WEBSITE TO SEE WHAT'S AVAILABLE**

**RESIDENTIAL / DECORATIVE**

**HIGH BAYS - UFO / LINEAR**

**AREA LIGHTS**

**WALLPACKS**

**BOLLARDS**

**SPORTS LIGHTS**

**FOLLOW US @MORRISPRODUCTS**



**53 CAREY ROAD QUEENSBURY, NY 12804  
MORRISPRODUCTS.COM  
1.888.777.6678**

**DEC 2024 / CAT#00022**

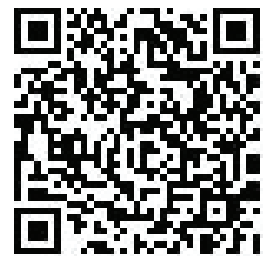

**SCAN ME**