



**SINGLE SOURCE...**  
**ELECTRICAL & LIGHTING**



# ***ELECTRICAL BOXES***

**MORRISPRODUCTS.COM**



**MORRIS**

INTRODUCING

# **SMARTOGGLE**

*THE ONLY STUD / NO-STUD OLD-WORK BOX*

**SEE PAGE 16-17  
FOR MORE INFO**



**MORRISPRODUCTS.COM**

# *Table Of Contents*

**STEEL BOXES** \_\_\_\_\_ **PG: 2 - 5**

**WEATHER PROOF** \_\_\_\_\_ **PG: 6 - 13**

**BOX ACCESORIES** \_\_\_\_\_ **PG: 14 - 15**

**SMARTOGGLE** \_\_\_\_\_ **PG: 16 - 17**

**FLOOR BOXES** \_\_\_\_\_ **PG: 18**

**NON-METALLIC**  
**RECESSED BOXES** \_\_\_\_\_ **PG: 19**

**ELECTRICAL BOXES**



# 4" Boxes

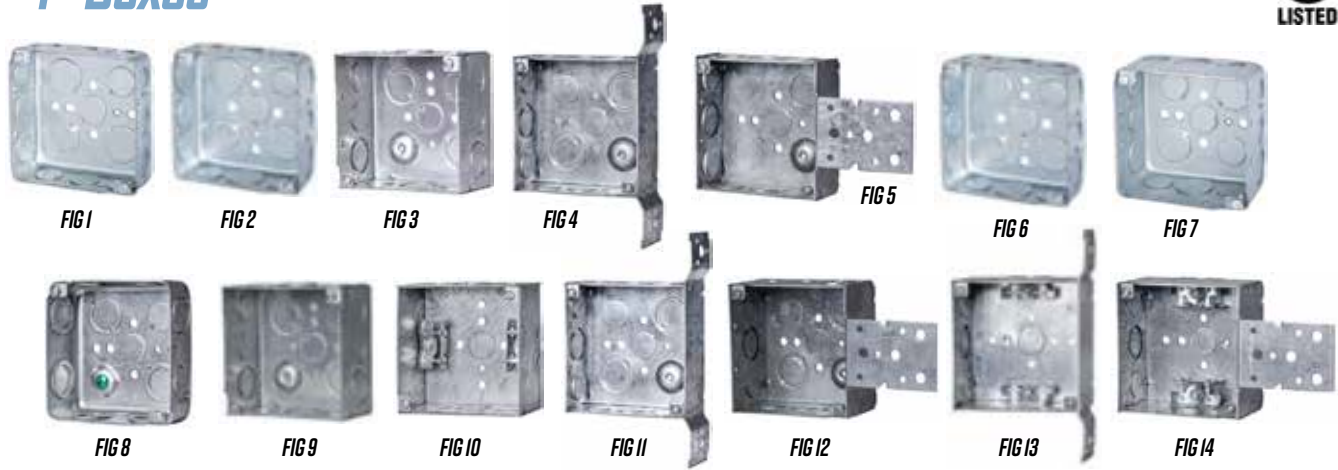

- Steel Construction
- Fire-Rated
- Available with 1/2" and/or 3/4" Knock Outs
- F-Brackets Mount to the Front of Studs
- S-Brackets Mount to the Side of Studs

CAT. NO.	FIG	RAISED GROUND	BRACKET	CONCENTRIC	KNOCKOUTS	MC CLAMPS	DRAWN OR WELDED	DIMENSIONS				CTN QTY
								LENGTH	WIDTH	DEPTH	CUB. IN.	
M190D	1				1/2"		DRAWN	4"	4"	1-1/2"	23"	50
M226D	2				1/2" & 3/4"		DRAWN	4"	4"	1-1/2"	23"	50
M189W	3			Y	1/2" & 3/4"		WELDED	4"	4"	1-1/2"	23"	50
M196W	4	Y	SIDE	Y	1/2" & 3/4"		WELDED	4"	4"	1-1/2"	23"	24
M193W	5	Y	FRONT	Y	1/2" & 3/4"		WELDED	4"	4"	1-1/2"	23"	24
M192D	6				1/2" & 3/4"		DRAWN	4"	4"	1-1/2"	33"	50
M232D	7				1/2" & 3/4"		DRAWN	4"	4"	2-1/8"	33"	50
M239D	8	Y		Y	1/2" & 3/4"		DRAWN	4"	4"	2-1/8"	33"	50
M231W	9	Y			1/2" & 3/4"		WELDED	4"	4"	2-1/8"	33"	24
M248W	10			Y	1/2" & 3/4"	Y	WELDED	4"	4"	2-1/8"	33"	24
M235W	11	Y	SIDE	Y	1/2" & 3/4"		WELDED	4"	4"	2-1/8"	33"	24
M251W	12	Y	FRONT	Y	1/2" & 3/4"		WELDED	4"	4"	2-1/8"	33"	24
M218W	13		SIDE	Y	1/2" & 3/4"	Y	WELDED	4"	4"	2-1/8"	33"	24
M249W	14		FRONT	Y	1/2" & 3/4"	Y	WELDED	4"	4"	2-1/8"	33"	24

# 4" Box Covers

- 4" Square
- Steel Construction
- Fire-Rated



CAT. NO.	FIG	DESCRIPTION	DIMENSIONS		CTN QTY
			LENGTH	WIDTH	
M752CC	1	4" BOX COVER BLANK	4"	4"	200
M753CC	2	4" BOX COVER 1/2" KO	4"	4"	200
M814CC	3	4" BOX COVER DECORATOR/TOGGLE	4"	4"	50
M906CC	4	4" BOX COVER DUPLEX/TOGGLE	4"	4"	50
M907CC	5	4" BOX COVER DUAL DUPLEX	4"	4"	50
M803CC	6	4" BOX COVER DUAL TOGGLE	4"	4"	50
M902CC	7	4" BOX COVER SINGLE DUPLEX	4"	4"	50
M800CC	8	4" BOX COVER SINGLE TOGGLE	4"	4"	50



FIG 1



FIG 2



FIG 3

## 4" Mud Rings

- 4" Square
- Steel Construction
- Fire-Rated

CAT. NO.	FIG	DESCRIPTION	DIMENSIONS		CTN QTY
			LENGTH	WIDTH	
M767MR	1	MUD RING CIRCULAR - RAISED 1/2"	4"	4"	50
M756MR	1	MUD RING CIRCULAR -RAISED 5/8"	4"	4"	50
M759MR	1	MUD RING CIRCULAR - RAISED 3/4"	4"	4"	50
M771MR	2	MUD RING SINGLE GANG - RAISED 1/4"	4"	4"	50
M772MR	2	MUD RING SINGLE GANG - RAISED 1/2"	4"	4"	50
M768MR	2	MUD RING SINGLE GANG - RAISED 5/8	4"	4"	50
M773MR	2	MUD RING SINGLE GANG - RAISED 3/4"	4"	4"	50
M774MR	2	MUD RING SINGLE GANG -RAISED 1"	4"	4"	25
M777MR	3	MUD RING TWO GANG -RAISED 1/4"	4"	4"	50
M778MR	3	MUD RING TWO GANG -RAISED 1/2"	4"	4"	50
M769MR	3	MUD RING TWO GANG -RAISED 5/8	4"	4"	50
M779MR	3	MUD RING TWO GANG -RAISED 3/4"	4"	4"	50
M780MR	3	MUD RING TWO GANG -RAISED 1"	4"	4"	25



FIG 1



FIG 2



FIG 3

## 4" Extension Rings

- 4" Square
- Steel Construction
- Fire Rated

CAT. NO.	FIG	KNOCKOUTS	DIMENSIONS				CTN QTY
			LENGTH	WIDTH	DEPTH	CUB. IN.	
M203E	1	1/2" & 3/4"	4"	4"	1-1/2"	23"	50
M204E	2	1/2"	4"	4"	1-1/2"	23"	50
M207E	3	1/2" & 3/4"	4"	4"	2-1/8"	33"	50



FIG 1



FIG 2



FIG 3



FIG 4



FIG 5

## 4-11/16" Boxes



- 4-11/16" Square
- Steel Construction
- Fire-Rated
- Available with 1/2" and/or 3/4" Knock Outs

CAT. NO.	FIG	RAISED GROUND	CONCENTRIC	KNOCKOUTS	DRAWN OR WELDED	DIMENSIONS				CTN QTY
						LENGTH	WIDTH	DEPTH	CUB. IN.	
M259W	1	Y	Y	1/2" & 3/4"	WELDED	4-11/16"	4-11/16"	2-1/8"	44"	50
M257W	2			1/2" & 3/4"	WELDED	4-11/16"	4-11/16"	2-1/8"	44"	50
M250E	3			1/2" & 3/4"		4-11/16"	4-11/16"	1-1/2"	32"	50
M832CC	4					4-11/16"	4-11/16"			200
M833CC	5			1/2"		4-11/16"	4-11/16"			200



# Octagon Boxes

- Steel Construction
- Fire-Rated
- Available with 1/2" and/or 3/4" Knock Outs
- S-Brackets Mount to the Side of Studs



CAT. NO.	FIG	BRACKET	RAISED GROUND	KNOCKOUTS	CLAMPS	DIMENSIONS				CTN QTY
						LENGTH	WIDTH	DEPTH	CUB. IN	
M8125R	1			1/2"		4"	4"	1-1/2"	15-1/2"	50
M127R	1			1/2" & 3/4"		4"	4"	1-1/2"	15-1/2"	50
M167R	2		Y	1/2" & 3/4"		4"	4"	2-1/8"	21-1/2"	50
M153R	3			1/2"	NM	4"	4"	1-1/2"	15-1/2"	50
M145R	4			1/2"	MC	4"	4"	1-1/2"	15-1/2"	50
M161R	6	SIDE		1/2"		4"	4"	1-1/2"	15-1/2"	50
M164R	7	SIDE		1/2"	NM	4"	4"	1-1/2"	15-1/2"	50
M155R	8	SIDE		1/2"	MC	4"	4"	1-1/2"	15-1/2"	50
M131E	5			1/2" & 3/4"		4"	4"	1-1/2"	23"	50

# Round/Pancake Boxes

- Steel Construction
- Fire-Rated
- Available with 1/2" Knock Outs



CAT. NO.	RAISED GROUND	KNOCKOUTS	DIMENSIONS				CTN QTY
			LENGTH	WIDTH	DEPTH	CUB. IN	
M293R	Y	1/2"	4"	4"	1/2"	6"	50

# Round & Octagon Box Covers

- Steel Construction
- Fire-Rated
- Available with 1/2" Knock Outs



FIG 1

FIG 2



CAT. NO.	FIG	DESCRIPTION	KNOCKOUTS	DIMENSIONS		CTN QTY
				LENGTH	WIDTH	
M707CC	1	BLANK		4"	4"	200
M703CC	2	WITH KO	1/2"	4"	4"	200

# Masonry Boxes

- Available with Single Gang, Multi-gang, and Gangable Designs
- Available with 1/2" & 3/4" Knock Outs
- Available with Concentric Knock Outs
- Steel Construction
- Fire-Rated



FIG 1

FIG 2

FIG 3

FIG 4



CAT. NO.	FIG	CONCENTRIC	KNOCKOUTS	DIMENSIONS				CTN QTY
				LENGTH	WIDTH	DEPTH	CUB. IN	
M689M	1		1/2" & 3/4"	3-3/4"	2"	2-1/2"	18-3/4"	25
M696M	2	Y	1/2" & 3/4"	3-3/4"	3-25/32"	2-1/2"	35-2/5"	20
M697M	3	Y	1/2" & 3/4"	3-3/4"	5-1/2"	2-1/2"	51-1/2"	10
M845CC	4			4-1/2"	7-7/8"			40



# Handy Boxes



- Single Gang
- Steel Construction
- Fire-Rated
- Available with 1/2" and/or 3/4" Knock Outs

CAT. NO.	FIG	KNOCKOUTS	RAISED GROUND	DIMENSIONS				CTN QTY
				LENGTH	WIDTH	DEPTH	CUB. IN	
M650H	1	1/2"		4"	2"	1-1/2"	12"	50
M660H	2	1/2"		4"	2"	1-7/8"	15"	50
M666H	3	1/2" & 3/4"	Y	4"	2"	1-7/8"	15"	50
M670H	4	1/2"		4"	2"	2-1/8"	17"	50
M674H	5	1/2" & 3/4"		4"	2"	2-1/8"	17"	50

# Handy Box Extension Rings

- Single Gang
- Steel Construction
- Fire-Rated
- Available with 1/2" and/or 3/4" Knock Outs



CAT. NO.	KNOCKOUTS	DIMENSIONS				CTN QTY
		LENGTH	WIDTH	DEPTH	CUB. IN	
M201E	1/2"	4"	2"	1-1/2"	12"	50
M665E	1/2" & 3/4"	4"	2"	1-7/8"	15"	50



# Handy Box Covers

- Single Gang
- Steel Construction
- Fire-Rated

CAT. NO.	FIG.	DESCRIPTION	KNOCKOUTS	DIMENSIONS		CTN QTY
				LENGTH	WIDTH	
M860CC	1	BLANK		4"	2"	200
M861CC	2	BLANK WITH KO	1/2"	4"	2"	200
M865CC	3	TOGGLE		4"	2"	200
M862CC	4	DECORATOR		4"	2"	50
M864CC	5	DUPLEX		4"	2"	50



# Switch Boxes

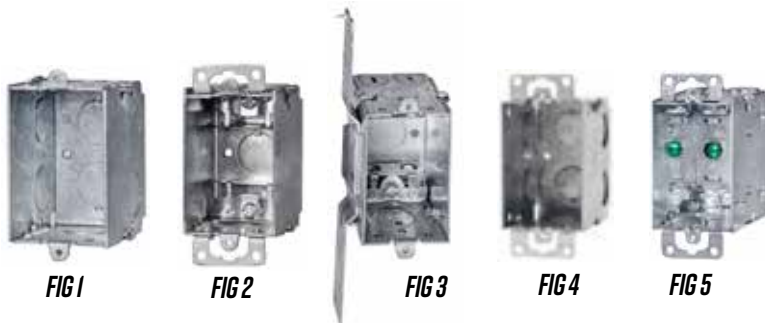

- Single Gang
- Steel Construction
- Fire-Rated
- S-Brackets Mount to the Side of Studs

CAT. NO.	FIG	BRACKET	KNOCKOUTS	MC CLAMP	TYPE	DIMENSIONS				CTN QTY
						LENGTH	WIDTH	DEPTH	CUB. IN	
M8500SB	1		1/2"		SWITCH BOX	3"	2"	2-1/2"	13"	50
M518SB	2		1/2"	MC	SWITCH BOX	3"	2"	2-1/2"	13"	50
M604SB	3	SIDE	1/2"	MC	SWITCH BOX	3"	2"	2-1/2"	13"	50
M596S	4		1/2"		GANGABLE BOX	3"	2"	2-1/2"	15"	50
M600S	5		1/2"	NM	GANGABLE BOX	3"	2"	2-1/2"	18"	50



# Weatherproof Boxes



Weatherproof Boxes

- Includes Closure Plugs
- Detachable Lugs Provided (Except Where Noted)
- Ground Screw Installed
- Reinforced Connector Outlets
- Brackets Secured with Screws
- Seamless Die Cast Aluminum
- Powder Coat Finish
- Individually Packaged



FIG 1



FIG 2



FIG 3



FIG 4

## One Gang - 18.3 Cubic Inch Capacity

Length 4-1/2" X Width 2-3/4" X Depth 2"

CAT. NO.	FIG	LUGS	NO. OF OUTLET HOLES	OUTLET HOLE DIA.	NO. OF CLOSURE PLUGS	FINISH	BOX QTY
36000	1	NO LUGS	3	1/2"	2	GRAY	50
36002	1	NO LUGS	3	1/2"	2	WHITE	50
36004	1	NO LUGS	3	1/2"	2	BRONZE	50
36010	1	LUGS	3	1/2"	2	GRAY	50
36012	1	LUGS	3	1/2"	2	WHITE	50
36014	1	LUGS	3	1/2"	2	BRONZE	50
36018	1	NO LUGS	3	3/4"	2	GRAY	50
36020	1	LUGS	3	3/4"	2	GRAY	50
36022	1	LUGS	3	3/4"	2	WHITE	50
36024	1	LUGS	3	3/4"	2	BRONZE	50
36028	2	NO LUGS	4	1/2"	2	GRAY	50
36030	2	LUGS	4	1/2"	2	GRAY	50
36032	2	LUGS	4	1/2"	2	WHITE	50
36034	2	LUGS	4	1/2"	2	BRONZE	50
36040	2	LUGS	4	3/4"	2	GRAY	50
36050	3	LUGS	5	1/2"	2	GRAY	50
36060	3	LUGS	5	3/4"	2	GRAY	50
36070	4	LUGS	5	1/2"	2	GRAY	50
36080	4	LUGS	5	3/4"	2	GRAY	50



FIG 5



FIG 6

## One Gang Deep - 23.8 Cubic Inch Capacity

Length 4-1/2" X Width 2-3/4" X Depth 2-5/8"

CAT. NO.	FIG	LUGS	NO. OF OUTLET HOLES	OUTLET HOLE DIA.	NO. OF CLOSURE PLUGS	FINISH	BOX QTY
36090	5	LUGS	3	1/2"	2	GRAY	40
36100	5	LUGS	3	3/4"	2	GRAY	40
36110	5	LUGS	3	1"	2	GRAY	40
36120	6	LUGS	5	1/2"	2	GRAY	40
36130	6	LUGS	5	3/4"	2	GRAY	40
36140	6	LUGS	5	1"	2	GRAY	40





# Weatherproof Boxes

## Two Gang Deep – 30.5 Cubic Inch Capacity Length 4-1/2" X Width 4-1/2" X Depth 2-3/16"

CAT. NO.	FIG	NO. OF OUTLET HOLES	OUTLET HOLE DIA.	NO. OF CLOSURE PLUGS	FINISH	BOX QTY
36210	1	3	1/2"	2	GRAY	40
36212	1	3	1/2"	2	WHITE	40
36214	1	3	1/2"	2	BRONZE	40
36220	1	3	3/4"	2	GRAY	40
36222	1	3	3/4"	2	WHITE	40
36224	1	3	3/4"	2	BRONZE	40
36230	2	4	1/2"	2	GRAY	40
36240	2	4	3/4"	2	GRAY	40
36250	3	5	1/2"	2	GRAY	40
36260	3	5	3/4"	2	GRAY	40
36270	4	5	1/2"	2	GRAY	40
36280	4	5	3/4"	2	GRAY	40
36290	5	6	1/2"	2	GRAY	40
36300	5	6	3/4"	2	GRAY	40
36310	6	7	1/2"	2	GRAY	40
36320	6	7	3/4"	2	GRAY	40
36330	7	7	1/2"	2	GRAY	40
36340	7	7	3/4"	2	GRAY	40
36350	8	9	1/2"	2	GRAY	40
36360	8	9	3/4"	2	GRAY	40

## Two Gang Deep – 37 Cubic Inch Capacity Length 4-1/2" X Width 4-1/2" X Depth 2-5/8"

CAT. NO.	FIG	NO. OF OUTLET HOLES	OUTLET HOLE DIA.	NO. OF CLOSURE PLUGS	FINISH	BOX QTY
36370	9	5	1/2"	2	GRAY	20
36380	9	5	3/4"	2	GRAY	20
36390	9	5	1"	2	GRAY	20
36400	10	7	1/2"	2	GRAY	20
36410	10	7	3/4"	2	GRAY	20
36420	10	7	1"	2	GRAY	20

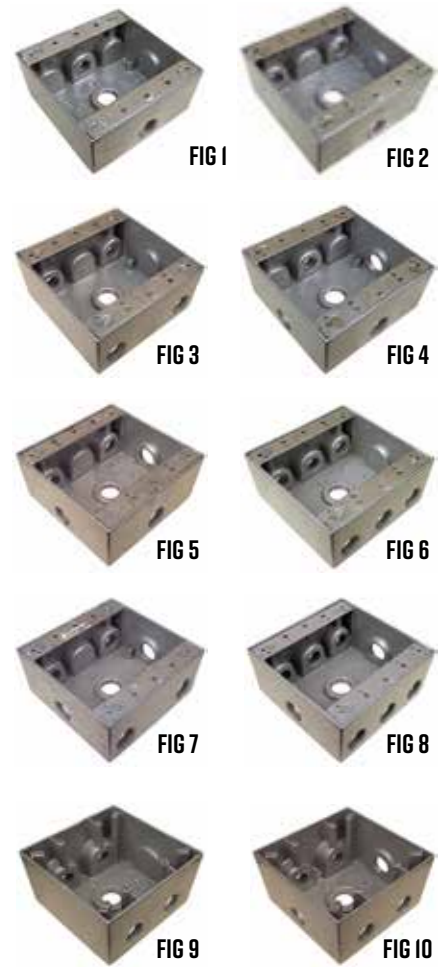

Weatherproof Boxes



# Weatherproof Box Extensions & Adapter Rings

- (36520~36550) Includes Closure Plugs
- Gasket & Mounting Screws Supplied
- Seamless Die Cast Aluminum
- Fits All Universal Type Weatherproof Boxes
- Powder Coat Finish



CAT. NO.	FIG	NO. OF OUTLET HOLES	OUTLET HOLE DIA.	NO. OF CLOSURE PLUGS	FINISH	DIMENSIONS				BOX QTY
						LENGTH	WIDTH	DEPTH	CUB. IN	
<b>ONE GANG EXTENSION RING</b>										
36510	1	-	-	-	GRAY	4-9/16"	2-13/16"	1"	9.3"	50
<b>TWO GANG EXTENSION RING</b>										
36512	2	-	-	-	GRAY	4-9/16"	4-9/16"	1"	16.4"	50
<b>ONE GANG FLANGED BOX EXTENSION ADAPTOR</b>										
36520	3	4	1/2"	2	GRAY	5-1/4"	3-1/2"	1-1/2"	12.8"	40
36530	3	4	3/4"	2	GRAY	5-1/4"	3-1/2"	1-1/2"	12.8"	40
36540	4	6	1/2"	2	GRAY	5-1/4"	3-1/2"	1-1/2"	12.8"	40
36550	4	6	3/4"	2	GRAY	5-1/4"	3-1/2"	1-1/2"	12.8"	40



# While-In-Use Weatherproof Covers



In-Use Weatherproof Covers



14 IN I



TWO GANG

31 IN I

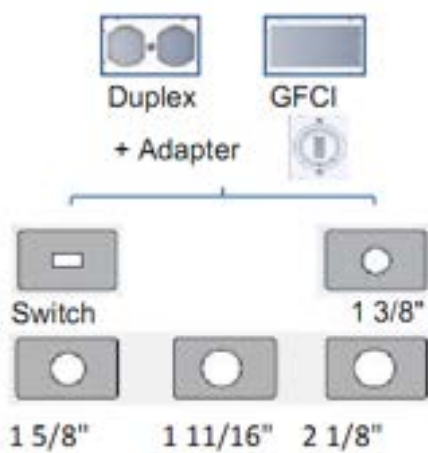

SEE CAT# 3891I FOR 31-I CONFIGURATIONS

- Weatherproof While-in-Use - Complies with NEC
- 1 Gang - 14 Device Configurations 2 Gang - 31 Device Configurations
- One Gang Mounts Vertically or Horizontally
- Heavy Duty Hidden Hinge
- Sturdy Polycarbonate Construction - Clear Cover
- Built-In Water Dam Design channels moisture away from interior
- Extra Large Gasketed Cord Flap for Cable Exit
- Lockable Latching Tab
- Pre-Installed Gasket

- Snap-In Device Adapter requires no tools to install
- Easy-To-Assemble building block style adapter provides flexibility and eliminates damage
- NEMA 3R rating
- \*3891D 2 Gang Cover will not support center mounted devices 3891D does not contain all 31 configurations outlined above. 3891D contains the following device plates: 2 decorative; 2 1-3/8" dia. single KO's only. For more configurations, ie. toggle or larger KO's use Cat# 3891I

CAT. NO.	DESCRIPTION	DIMENSIONS			CASE QTY
		DEPTH	LENGTH	WIDTH	
38900	1 GANG	3.20"	5.60"	3.85"	24
38901	1 GANG DEEP	3.75"	5.60"	3.85"	24
38910	2 GANG	2.75"	4.70"	4.70"	30
3891I	2 GANG DEEP	3.65"	5.60"	5.45"	10



# Metal While-In-Use Weatherproof Covers Die Cast Aluminum

In-Use Weatherproof Covers

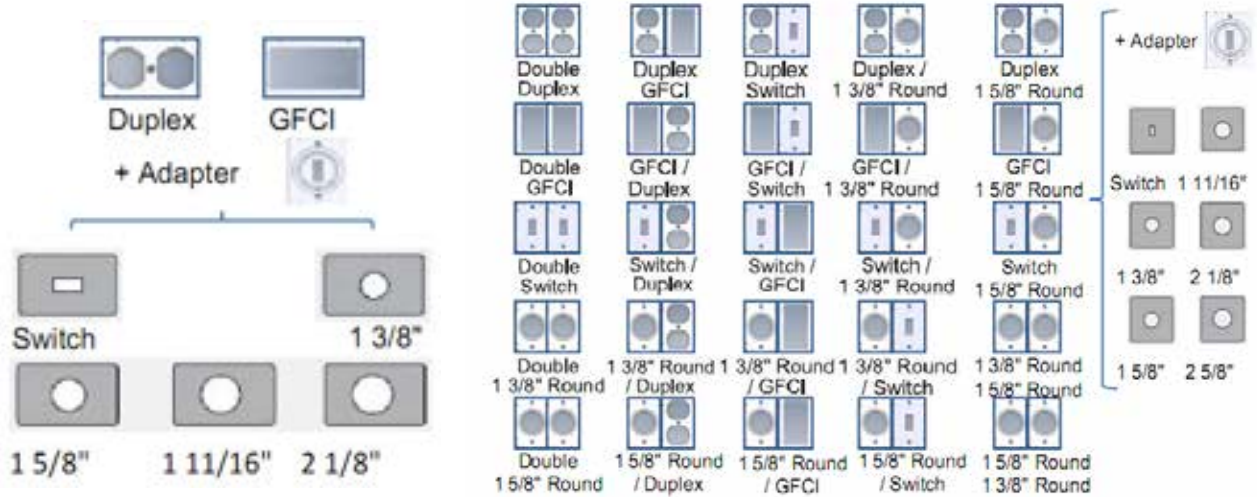
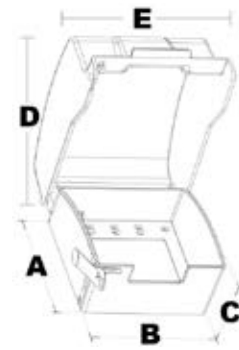
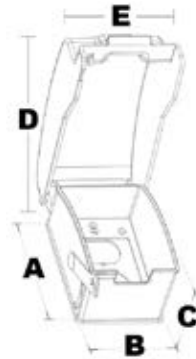

- Weatherproof While-in-Use - Complies with NEC
- 1 Gang - 7 Device Configurations 2 Gang - 31 Device Configurations
- Patented Cover Adjustable from 2-3/4" to 3-1/2" (2 Gang Adjustable from 3-1/2" to 4-1/2" Depth)
- One Gang Covers Can Be Mounted Vertically or Horizontally - See Table Below
- Heavy Duty Reinforced Hidden Hinge - 40lb Force Rating
- Sturdy Die-Cast Aluminum Construction
- Built-In Water Dam Design channels moisture away from interior

- Extra Large Cable Exit
- Lockable Latching Tab
- Pre-Installed Gasket
- Easy-To-Assemble Building Block Style Snap-In Device Adapter requires no tools and provides flexibility and eliminates damage
- NEMA 3R rating
- Ground Lug Included

CAT. NO.	DESCRIPTION	COLOR	DIMENSIONS					CASE QTY
			A	B	C	D	E	
38915	1 GANG - VERTICAL	GRAY	4.60"	3.10"	3.00"	6.80"	3.50"	10
38912	1 GANG - VERTICAL	WHITE	4.60"	3.10"	3.00"	6.80"	3.50"	10
38916	1 GANG - HORIZONTAL	GRAY	4.60"	3.10"	3.00"	6.80"	3.50"	10
38913	1 GANG - HORIZONTAL	WHITE	4.60"	3.10"	3.00"	6.80"	3.50"	10
38917	2 GANG DEEP - VERTICAL	GRAY	4.60"	4.60"	3.20"	6.80"	5.25"	10
38914	2 GANG DEEP - VERTICAL	WHITE	4.60"	4.60"	3.20"	6.80"	5.25"	10



# 4" Round Weatherproof Boxes & Extensions



FIG 1



FIG 2

15.8 Cubic Inch Capacity - 1-1/2" Deep

- Includes Closure Plugs
- Ground Screw Installed in Boxes
- Seamless Die Cast Aluminum
- Powder Coat Finish
- Individually Packaged
- Box Extensions Include Gasket

CAT. NO.	FIG	NO. OF OUTLET HOLES	OUTLET HOLE DIA.	NO. OF CLOSURE PLUGS	FINISH	BOX QTY
<b>4" ROUND WEATHERPROOF BOXES</b>						
36610	1	5	1/2"	4	GRAY	40
36612	1	5	1/2"	4	WHITE	40
36614	1	5	1/2"	4	BRONZE	40
36620	1	5	3/4"	4	GRAY	40
<b>4" ROUND WEATHERPROOF BOX EXTENSIONS</b>						
36710	2	4	1/2"	3	GRAY	40
36720	2	4	3/4"	3	GRAY	40

Weatherproof Boxes / Covers

# 4" Round Weatherproof Covers



FIG 1



FIG 2



FIG 3



FIG 4

- Includes Closure Plugs
- Gasket & Mounting Screws Supplied
- Seamless Die Cast Aluminum
- Powder Coat Finish
- Individually Packaged

CAT. NO.	FIG	NO. OF OUTLET HOLES	OUTLET HOLE DIA.	NO. OF CLOSURE PLUGS	FINISH	BOX QTY
36810	1	1	1/2"	-	GRAY	50
36812	1	1	1/2"	-	WHITE	50
36814	1	1	1/2"	-	BRONZE	50
36830	2	3	1/2"	1	GRAY	50
36832	2	3	1/2"	1	WHITE	50
36834	2	3	1/2"	1	BRONZE	50
36840	3	3	1/2"	1	GRAY	50
36842	3	3	1/2"	1	WHITE	50
36844	3	3	1/2"	1	BRONZE	50
36850	4	BLANK			GRAY	100

# Weatherproof Switch Covers



37290

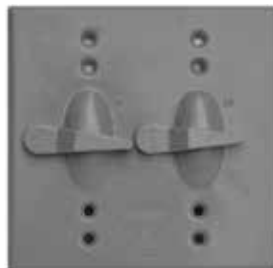

37291

- Weatherproof Protection for On-Off Switch Applications
- Seamless Die Cast Aluminum
- Powder Coat Finish
- Pre-Installed Gasket & Mounting Screws Supplied

CAT. NO.	DESCRIPTION	COLOR	CASE QTY
37290	SINGLE TOGGLE SWITCH	GRAY	50
37291	2 TOGGLE SWITCH	GRAY	24



# One Gang Weatherproof Covers



- Self Closing Lids
- Lampholder Covers Include Closure Plugs
- Gasket & Mounting Screws Included
- Seamless Die Cast Aluminum
- Powder Coat Finish
- Individually Packaged

## Horizontal One Gang Covers

CAT. NO.	FIG	DESCRIPTION	FINISH	BOX QTY
37010	1	DUPLEX RECEPTACLE	GRAY	50
37012	1	DUPLEX RECEPTACLE	WHITE	50
37014	1	DUPLEX RECEPTACLE	BRONZE	50
37020	2	GFCI/DECORATOR	GRAY	50
37022	2	GFCI/DECORATOR	WHITE	50
37024	2	GFCI/DECORATOR	BRONZE	50



FIG 1



FIG 2

## Vertical One Gang Covers

CAT. NO.	FIG	DESCRIPTION	FINISH	BOX QTY
37110	3	SINGLE RECEPTACLE	GRAY	50
37112	3	SINGLE RECEPTACLE	WHITE	50
37114	3	SINGLE RECEPTACLE	BRONZE	50
37120	4	DUPLEX RECEPTACLE	GRAY	50
37122	4	DUPLEX RECEPTACLE	WHITE	50
37124	4	DUPLEX RECEPTACLE	BRONZE	50
37130	5	GFCI/DECORATOR	GRAY	50
37132	5	GFCI/DECORATOR	WHITE	50
37134	5	GFCI/DECORATOR	BRONZE	50
37150	6	20A & 30A TWIST LOCK RECEPTACLE 1.625" OPENING	GRAY	50
37160	6	30A 3 & 4 WIRE TWIST LOCK RECEPTACLE 1.75" OPENING	GRAY	50
37170	7	30A DRYER & 50A RANGE RECEPTACLE 2.125" OPENING	GRAY	50
37180	8	BLANK	GRAY	100
37182	8	BLANK	WHITE	100
37184	8	BLANK	BRONZE	100



FIG 3



FIG 4



FIG 5



FIG 6



FIG 7



FIG 8

## Rectangular Lampholder Covers

CAT. NO.	FIG	DESCRIPTION	NO. OF CLOSURE PLUGS	FINISH	BOX QTY
37310	9	1 - 1/2" HOLE	-	GRAY	50
37312	9	1 - 1/2" HOLE	-	WHITE	50
37314	9	1 - 1/2" HOLE	-	BRONZE	50
37330	10	3 - 1/2" HOLE	1	GRAY	50
37332	10	3 - 1/2" HOLE	1	WHITE	50
37334	10	3 - 1/2" HOLE	1	BRONZE	50



FIG 9



FIG 10

Weatherproof Covers



# Two Gang Weatherproof Covers



- Gasket & Mounting Screws Supplied
- Seamless Die Cast Aluminum
- Powder Coat Finish
- Self Closing Spring Loaded Lids
- Individually Packaged



CAT. NO.	FIG	DESCRIPTION	FINISH	BOX QTY
37210	1	2 DUPLEX RECEPTACLES	GRAY	50
37212	1	2 DUPLEX RECEPTACLES	WHITE	50
37214	1	2 DUPLEX RECEPTACLES	BRONZE	50
37220	2	1 GFCI & 1 DUPLEX RECEPTACLE	GRAY	50
37222	2	1 GFCI & 1 DUPLEX RECEPTACLE	WHITE	50
37224	2	1 GFCI & 1 DUPLEX RECEPTACLE	BRONZE	50
37226	3	2 SINGLE RECEPTACLES 1.375" OPENING	GRAY	50
37230	4	1 SINGLE RECEPTACLE 1.375" & 1 DUPLEX RECEPTACLE	GRAY	50
37240	5	1 GFCI & 1 SINGLE RECEPTACLE 1.375"	GRAY	50
37250	6	2 GFCI RECEPTACLES	GRAY	50
37260	7	BLANK COVER	GRAY	50
37262	7	BLANK COVER	WHITE	50
37264	7	BLANK COVER	BRONZE	50

Weatherproof Covers

# Multi-Use Weatherproof Covers

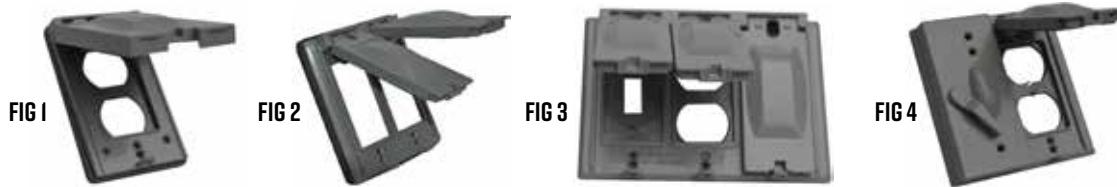

38920  
Duplex GFCI Switch 1 3/8" 1 5/8"



38921  
Duplex GFCI Switch 1 3/8" 1 5/8"



38922/38923

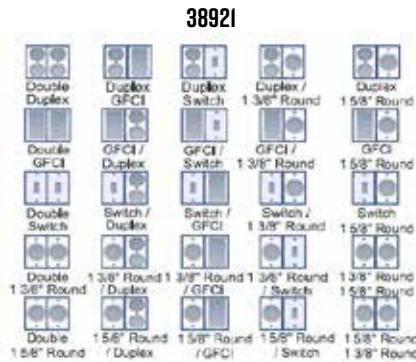

- Heavy-Duty Aluminum Die Cast Metal Construction
- 1 Gang - 10 Device Configurations
- 2 Gang - 25 Device Configurations
- 3 Gang - 125 Device Configurations
- 2 Gang w/Switch - 5 Configurations
- Heavy Duty Hidden Hinge
- Lockable Tab Feature Secures Cover
- Pre-Installed Gasket
- Snap-In device adapter requires no tools to install
- Easy-To-Assemble building block style adapters

CAT. NO.	FIG	DESCRIPTION	CONFIGURATIONS	LENGTH	WIDTH	CASE QTY
38920	1	1 GANG	10	4.6"	3.0"	50
38921	2	2 GANG	25	4.6"	4.5"	24
38922	3	3 GANG	125	4.6"	6.3"	20
38923	4	2 GANG W/SWITCH	5	4.6"	4.5"	50



- Gasket & Mounting Screws Supplied
- Seamless Die Cast Aluminum
- Powder Coat Finish
- For 75 Thru 150 Watt PAR 38 Lamps
- Extra Long Wire Leads for Easy Hook-Up
- Locking Swivel Knuckle Assures Positive Lamp Positioning and Provides Pinpoint Directional Aiming
- Each Lampholder Supplied With a Copper Screw Shell Porcelain Socket (37408 Aluminum Shell), Inside Gasket & 1/2" Locknut
- Press Fit Internal Heat Resistant Gasket Designed Not to Come Out When Bulb is Changed
- External Gasket Included
- Individually Packaged



CAT. NO.	FINISH	BOX QTY
37408	UNPAINTED	50
37410	GRAY	50
37412	WHITE	50
37414	BRONZE	50

## Hole Plugs and Accessories



FIG 1



FIG 2



FIG 3



FIG 4



FIG 5

**GASKETS**

- 1 Gang Blank
- 1 Gang Decorative
- 1 Gang Switch
- 1 Gang Single Receptacle

KO Dim: 1.43" 1.76" 2.18"

Use 37930

FIG 6

**GASKETS**

- 2 Gang Blank
- 2 Gang Decorative
- 2 Gang Switch
- 2 Gang Single Receptacle

Use 37934

FIG 7

CAT. NO.	FIG.	DESCRIPTION	FINISH	BAG QTY	BOX QTY
37510	1	1/2" HOLE PLUG	GRAY	10	800
37512	1	1/2" HOLE PLUG	WHITE	10	800
37514	1	1/2" HOLE PLUG	BRONZE	10	800
37520	1	3/4" HOLE PLUG	GRAY	10	500
37522	1	3/4" HOLE PLUG	WHITE	10	500
37524	1	3/4" HOLE PLUG	BRONZE	10	500
37530	1	1" HOLE PLUG	GRAY	10	300
37910	2	MOUNTING LUG	GRAY	10	500
37920	3	LAMPHOLDER INSIDE GASKET	--	-	300
37936	4	4" ROUND GASKET	--	-	100
38407	5	EXTERNAL PAR LAMPHOLDER GASKET (37408-37414)	--	-	250
37930	6	1 GANG SWITCH/RECEPTACLE/GFCI GASKET	--	-	200
37934	7	2 GANG SWITCH/RECEPTACLE/GFCI GASKET	--	-	100



## Box to Stud Fastener



- Screw attached support for box and conduit
- For use with either metal or wood studs
- Electrical box support clip secured with Self tapping screws for wood or metal studs

CAT. NO.	DESCRIPTION	BOX QTY
18345	BOX TO STUD FASTENER	100

## Far Side Box Support

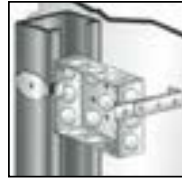

- Clips on electrical boxes for additional support
- 2-1/2" thru 4" Standoff
- Sized by Bending at Pre-marked Lines

CAT. NO.	DESCRIPTION	BOX QTY
18350	FAR SIDE BOX SUPPORT	100

## Screwless Box Support

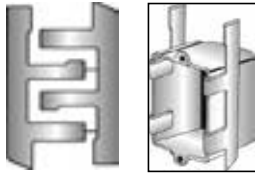

- Made from pre-galvanized steel
- Secures electrical box to finished drywall
- No stud necessary
- Fits 1/4"-20 Bolt

CAT. NO.	DESCRIPTION	BOX QTY
18375	BOX SUPPORT	100

## Low Voltage Mounting Bracket



- Provides base for securing communications plates without use of electrical box
- Mounts standard plate
- Hardware included

CAT. NO.	DESCRIPTION	ORDER IN BAG QTY
18376	LOW VOLTAGE MOUNTING BRACKET	10

## Box Stabilizer Support

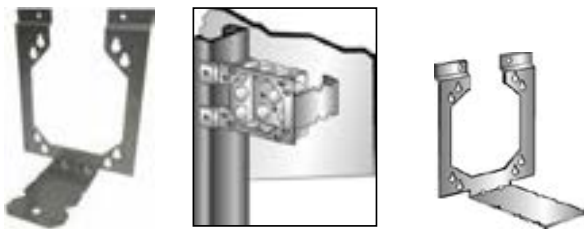

- Box Support for 2-1/2", 3-1/2" & 4" wood or metal studs
- Screw attached support for electrical boxes
- Made from pre-galvanized steel

CAT. NO.	STUD SIZE	BOX QTY
18370	2-1/2", 3-1/2"	100
18052	2-1/2", 3-1/2", 4"	100

## Plastic Far Side Box Support

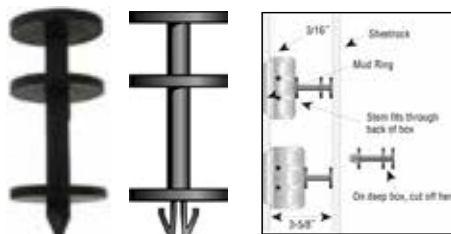

- No tools required
- Mounts quickly in the back of the box
- Designed for 3-5/8" steel studs
- May be used on standard 1-1/2" or 2-1/8" deep boxes

CAT. NO.	DESCRIPTION	BOX QTY
18378	PLASTIC FAR SIDE BOX SUPPORT	100



# Box Mounting Brackets

- Supports electrical boxes located between studs on 16" or 24" centers
- Boxes attach using self-tapping screws
- Made from pre-galvanized steel

CAT. NO.	DESCRIPTION	BOX QTY
18355	1-1/2" BOX TO STUDS ON 16" CENTERS	50
18356	2-1/8" BOX TO STUDS ON 16" CENTERS	50
18357	1-1/2" BOX TO STUDS ON 24" CENTERS	50
18358	2-1/8" BOX TO STUDS ON 24" CENTERS	50

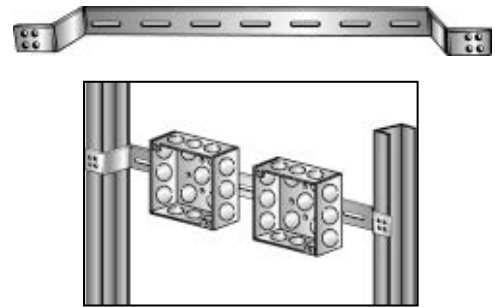

# Conduit/Box to Stud Fastener

- Secures conduit and electrical boxes to most structures
- Provides conduit support on both sides of electrical box
- Hole for screw or threaded rod mount with 1/4"-20 x 5/8" stud
- Made from pre-galvanized steel
- Spring steel fasteners riveted to bar
- Secures 1/2" & 3/4" Conduit

CAT. NO.	DESCRIPTION	BOX QTY
18360	MOUNT 4" SQUARE BOX WITH 1/2" OR 3/4" CONDUIT	25

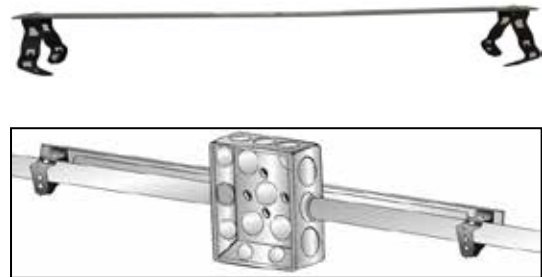

# Ceiling Box Bar Support

- Used where boxes need to be supported between structural members
- Adjustable Ceiling Box/Fixture Support

CAT. NO.	DIMENSIONS			BOX QTY
	A	B	C	
19000	10.65"	2.17"	1.22"	50

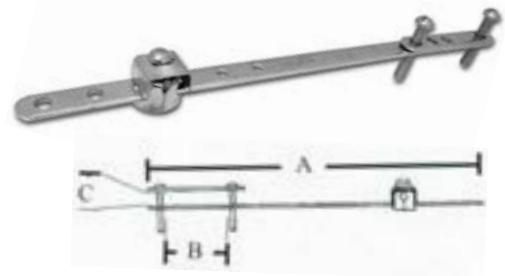

# Box To T-Bar Fastener

- Snap-on 24" span box hanger with dual height adjustment allows flush or 3/4" offset mount
- Mounting clip with screw included
- Pre-galvanized steel with spring steel hardware included

CAT. NO.	DESCRIPTION	BOX QTY
18054	24" SPAN BOX TO T-BAR FASTENER	100



# SMART TOGGLE

**THE ONLY STUD / NO-STUD OLD-WORK BOX**  
SAVES CONTRACTORS TIME, MONEY, AND LABOR

## WALL BOXES

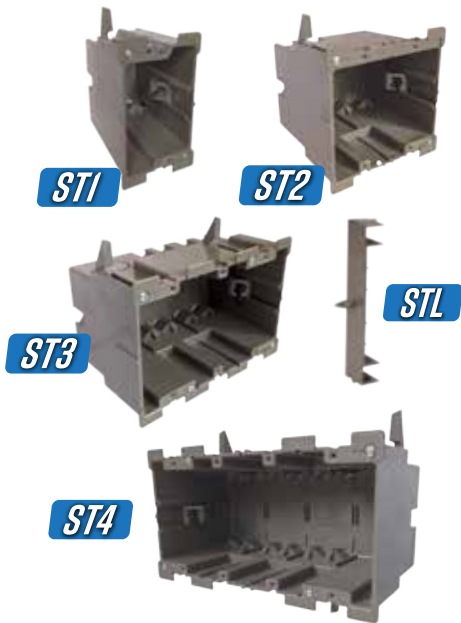

STUD / NO-STUD OLD-WORK BOX  
1-4 GANG WALL BOXES

ST1 FIXTURE RATED FOR 50LBS.  
WHEN FASTENED TO STUD; NOT FAN RATED

BUILT IN KNOCK OUTS

1-1/2" LONG TOGGLES THAT SNAP IN PLACE

SINGLE SCREW REMOVABLE MOUNTING BLOCK

QUICKLY LOCATE THE EXACT CENTER

NO-DROP TABS

## CEILING BOXES

**STR**



BUILT IN PILOT GUIDE LOCATOR

BUILT IN KNOCK OUTS

BURRS TO SCORE THE PERFECT HOLE SIZE  
AND SKIP TRACING ON THE CEILING

50 LB. CEILING RATED  
WHEN FASTENED TO STUD; NOT FAN RATED



**SAVE ON TIME AND LABOR**

**MSBST150**



CEILING RATED OLD-WORK BOX

RATED FOR 8 LBS.

LOW PROFILE

## ACCESSORIES

**STL**

**CENTER LOCATOR CLIP**



FIND THE PERFECT CENTER

USE THE STL CENTER LOCATOR CLIP WITH  
ST1, ST2, ST3, AND ST4

**INCLUDED WITH THE ST1 OR SOLD SEPARATELY:**

THE STL MAY BE USED WITH  
OTHER OLD-WORK BOXES

**ST2W ST3/4W**

**POWER/LOW VOLTAGE DIVIDERS**



USE FOR POWER AND  
LOW VOLTAGE  
APPLICATIONS

**ST2W - FOR ST2  
BOXES**

**ST3/4W - FOR ST3 &  
ST4 BOXES**



# SMARTOGGLE WALL BOX

FIG 1



FIG 2



FIG 3



FIG 4



FIG 5



FIG 6



FIG 7



CAT. NO.	FIG	GANG	TOGGLE DEPTH	FIXTURE SUPPORT RATING	KNOCK-OUTS	DIMENSIONS				CTN QTY
						LENGTH	WIDTH	DEPTH	CUBIC IN	
ST1	1	1	1-1/2"	50 LB*	0	4-1/4"	2"	3-3/4"	19-1/2"	50
ST2	2	2	1-1/2"	N/A	2	4-1/4"	4"	3-3/4"	39-1/2"	30
ST3	3	3	1-1/2"	N/A	2	4-1/4"	6"	3-1/2"	56-1/2"	20
ST4	4	4	1-1/2"	N/A	2	4-1/4"	7-3/4"	3-1/2"	74"	20
<b>ACCESSORIES</b>										
STL	5	LOCATOR ACCESSORY								100
ST2W	6	2 GANG DIVIDER ACCESSORY								100
ST3/4W	7	3 & 4 GANG DIVIDER ACCESSORY								100

\* WHEN FASTENED TO STUD; NOT FAN RATED



# SMARTOGGLE CEILING BOX

CAT. NO.	DESCRIPTION	TOGGLE DEPTH	FIXTURE SUPPORT RATING	KNOCK-OUTS	WIRING INFO	DIMENSIONS			CTN QTY
						LENGTH	DEPTH	CUB. IN.	
STR	3-1/2" ROUND BOX	3/4"	*50 LB / 8 LB	2	9 - #14 8 - #12 7 - #10	3-1/2"	2-3/4"	19.3	30

\* WHEN FASTENED TO STUD; NOT FAN RATED



CAT. NO.	DESCRIPTION	TOGGLE DEPTH	FIXTURE SUPPORT RATING	KNOCK-OUTS	WIRING INFO	DIMENSIONS			CTN QTY
						LENGTH	DEPTH	CUB. IN.	
MSBST150	3-1/2" ROUND BOX	3/4"	8 LB	0	4-#14 4-#12	4"	1-1/2"	9"	30



# Residential Floor Boxes



Floor Boxes



84000 - 84001

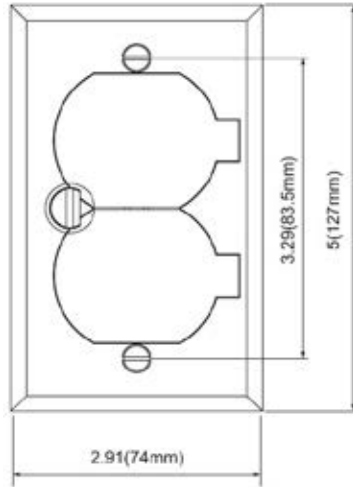

84002 - 84003

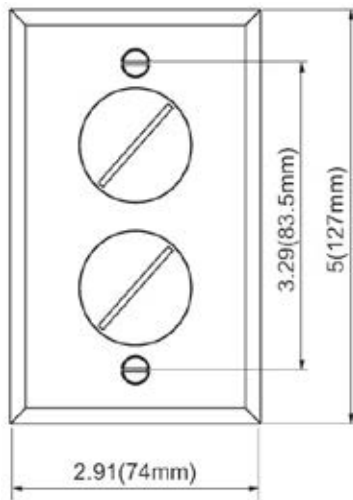

- Heavy duty Brass or Nickel Plated Brass covers
- Junction Box, duplex receptacle & rubber gasketed cover included
- Good for tile and carpet applications
- Adjustable to make installs easy
- 1/2" Conduit Knockouts
- Fits manufacturer's 3-1/2" deep switch box
- Can accommodate data-communications inserts
- Includes 15A 125V White TamperProof Receptacle
- UL 351B & UL 498 listed receptacles

CAT. NO.	COVER MATERIAL	INNER BOX	OUTER BOX
<b>HINGED LID DUPLEX FLOOR BOX ASSEMBLY</b>			
84000	BRASS	I	20
84001	NICKEL PLATED BRASS	I	20
<b>SCREW LID DUPLEX FLOOR BOX ASSEMBLY</b>			
84002	BRASS	I	20
84003	NICKEL PLATED BRASS	I	20



# Non-Metallic Recessed Boxes

- Perfect in homes, apartments, co-ops, condominiums and offices
- Flush Mounting, Installs behind wall units and entertainment centers
- Polycarbonate Construction
- Includes Face Plate
- Receptacles are 15A, 125V Self Grounding

Non-Metallic Recessed Boxes



FIG 1



FIG 2



FIG 3



FIG 4



FIG 5



FIG 6



FIG 7



FIG 8



FIG 9

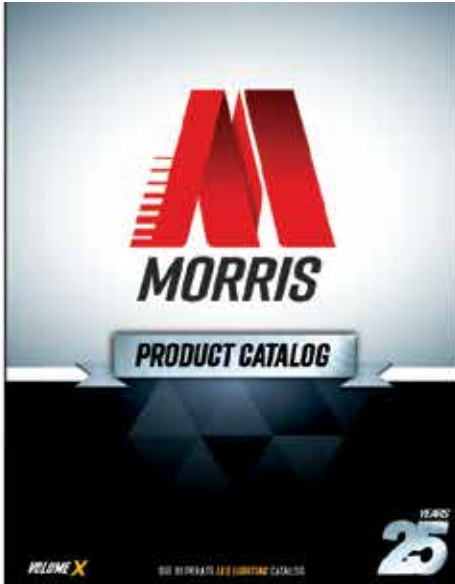

FIG 10

CAT. NO.	FIG	DESCRIPTION	DIMENSIONS			CTN QTY
			LENGTH	WIDTH	DEPTH	
84004	1	DECORATOR RECESSED DUPLEX RECEPTACLE WITH WALL PLATE	4.5"	2.75"	1.94"	60
84005	2	SINGLE-GANG RECESSED RECEPTACLE WITH WALL PLATE	4.5"	2.75"	1.98"	60
84006	3	SINGLE-GANG RECESSED PLUG WITH WALL PLATE	4.5"	2.75"	1.74"	60
84007	4	TWO GANG LOW VOLTAGE CABLE PLATE & RECESSED PLUG	4.5"	5.18"	1.74"	60
84008	5	TWO GANG LOW VOLTAGE CABLE PLATE WITH RECESSED RECEPTACLE	4.5"	4.6"	1.97"	60
84009	6	SINGLE-GANG RECESSED LOW VOLTAGE CABLE PLATE	4.5"	2.75"	1.65"	60
84010	7	2-GANG RECESSED LOW VOLTAGE CABLE PLATE	4.5"	4.55"	1.65"	60
84011	8	SINGLE BRUSH DECORATOR PLATE WITH WALLPLATE	4.09"	2.75"	.42"	200
84012	9	SPLIT STYLE TV PLATE WITH FLEXIBLE AV/HDMI CABLE PASS-THROUGH WITH WALLPLATE	4.5"	2.75"	0.22"	200
84013	10	RECESSED PRO POWER INSTALLTION KIT THIS SET OF PRODUCT INCLUDES THE FOLLOWING PRODUCTS: 1 PC 84007 1 PC 84008 2 PCS JUNCTION BOX 2 PCS LOW VOLTAGE MOUNTING BRACKET 1 PC JUMPER CABLE 1 PC POWER CORD	-	-	-	12

# SEE OUR FULL LINE OF PRODUCTS

VISIT [MORRISPRODUCTS.COM](http://MORRISPRODUCTS.COM)



**ELECTRICAL CATALOG**  
CAT#00000

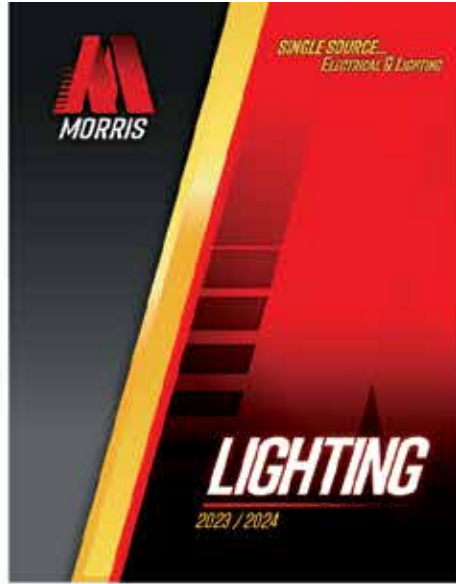

**2023/2024 LIGHTING CATALOG**  
CAT#00022



**2024 LIGHTING CLEARANCE**  
ONLINE ONLY



**HVAC CATALOG**  
CAT#00014



**FITTINGS CATALOG**  
CAT#00024



**EXIT & EMERGENCY CATALOG**  
CAT#00012

**CATALOGS ARE AVAILABLE TO DOWNLOAD OR  
CONTACT YOUR LOCAL MORRIS REP**



# SMARTOGGLE

THE ONLY STUD / NO-STUD OLD-WORK BOX

SEE PAGE 16-17

## WALL BOXES

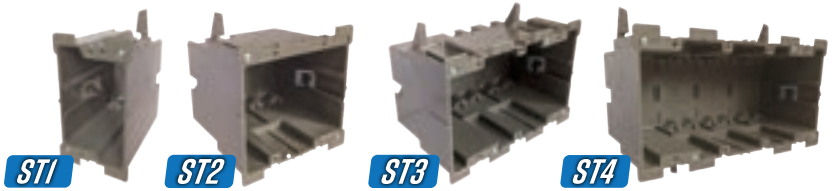

## CEILING BOXES



CEILING BOX WITH  
INTEGRATED HOLE SAW

SAVE ON TIME AND LABOR

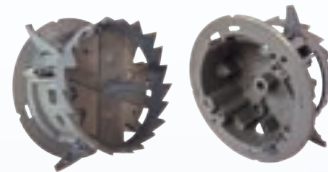

MSBST150

## ACCESSORIES



STL

CENTER LOCATOR CLIP



ST2W

ST3/4W

POWER/LOW  
VOLTAGE DIVIDERS

MORRIS PRODUCTS INC.  
53 CAREY ROAD  
QUEENSBURY, NY 12804  
INFO@MORRISPRODUCTS.COM  
1.888.777.6678



**SINGLE SOURCE...**  
**ELECTRICAL & LIGHTING**